

C·Bath

A new bathroom experience
by Cosentino®

The Bathelier

The Bathelier is Cosentino®'s concept that embodies the vision of a unique, experience-oriented space through renowned designers who interpret bathrooms of the future: unusual, unique and seamless.

REMY MEIJERS, CLAUDIA AFSHAR, DANIEL GERMANI,
COLIN SEAH AND MUT DESIGN

COSENTINO®

Get inspired at [cosentino.com](https://www.cosentino.com)



C·Bath

A new bathroom experience
by Cosentino®

The Bathelier by Remy Meijers, Claudia Afshar,
Daniel Germani, Colin Seah and MUT Design.

©2023 Cosentino®

Cosentino S. A.
Ctra. A334 Baza-Huércal Overa, km. 59
04850 Cantoria, Almería, Spain
(+34) 950 444 175 (switchboard)
(+34) 950 543 039 (customer service)

www.cosentino.com

The Bathelier

The Bathelier is Cosentino®'s concept that embodies the vision of a unique, experience-oriented space through renowned designers who interpret bathrooms of the future: unusual, unique and seamless.

REMY MEIJERS, CLAUDIA AFSHAR, DANIEL GERMANI,
COLIN SEAH AND MUT DESIGN

COSENTINO

C·Bath

A NEW BATHROOM EXPERIENCE BY COSENTINO®

C-Bath is Cosentino®'s comprehensive approach to reimagining bathroom spaces through design and technology.

A complete vision of the space from a new perspective. Innovation in the design of unique and personalised atmospheres, featuring large format wall and floor cladding and minimum number of joints, colours and textures in perfect balance, minimalist wash basins and shower trays designed in detail. Manufactured with state of the art materials such as Silestone®, Dekton® and Sensa, C-Bath gives a fresh look to your bathroom.

C-Bath is the experience of designing a bathroom to suit you, a personal space in which to find serenity and wellbeing: a bathroom to be lived in.

Bathrooms where creativity is at its best with The Bathelier: exclusive collections created by designers from all over the world for C-Bath.

A creative look at bathroom space, where art and functionality converge.



Index

Cosentino® P. 10



To inspire people through innovative and sustainable spaces

The Bathelier P. 16

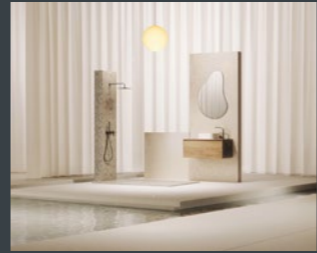

Remy Meijers	20
Claudia Afshar	34
Daniel Germani	48
Colin Seah	62
MUT Design	76

C-Bath P. 90

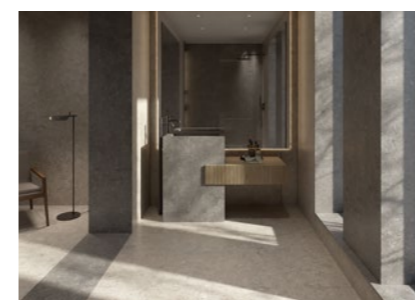

C-Bath Studio P. 92



Projects P. 124



Overall bathroom concept P. 152



Materials P. 156

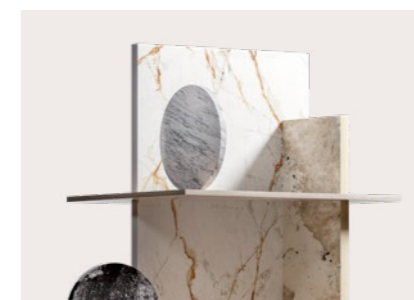

Colour Range P. 172



Flooring & Cladding P. 182

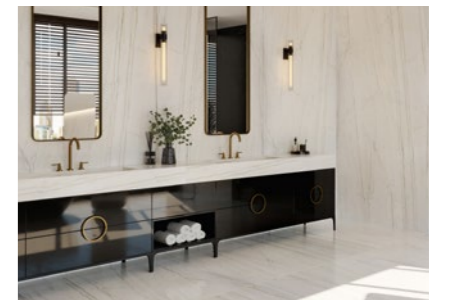

Wash basins & Shower trays P. 190



Accessories P. 236



We seek a **more valuable, meaningful** and comprehensive benefit.

Enriched and balanced **with the positive impact of everything we do.** **Good for people's lives, the development of their communities and the planet we live on.**

A growth that harmonises **the benefits of today with those of the future.** **A growth that is responsible for the consequences of our activity.**

A benefit to keep growing, but in an ever better world.

Photovoltaic plant at Cosentino Industrial Park

Cosentino®



To inspire people
through innovative and
sustainable spaces

Cosentino® Sustainability

At Cosentino® we approach sustainability as a collective commitment that stems from the individual involvement of those that are part of Cosentino®.

Our continuous improvement efforts involve a constant analysis of our entire value chain – from the procurement of raw materials to the delivery of end products to our customers.

At Cosentino® we are strongly committed to the 2030 Agenda promoted by the United Nations. The company, in view of its position as a global leader in the production and distribution of innovative surfaces for decoration and architecture from its Almería base, is committed to driving both local and global sustainability efforts.

Water

Since our inception, we have appreciated the importance and understood the challenges of correct water management.

This has motivated us to implement a sustainable use policy maximising the efficient use of water resources in the different production processes.

We use cutting edge technology to achieve 99% recycled water in all our production processes at Cosentino®'s industrial park.

Additionally, we use 100% of surplus water to irrigate green areas.

Materials

We are aware of the importance of making the most of the materials we work with, both from the beginning of their life cycle to the end of the value chain.

With this goal in mind, in recent years we have embarked on an ambitious R&D project called 'Circularity' to reuse the materials from which we manufacture our products.

Another action is the disruptive HybriQ+ technology that brings about the new generation of Silestone®. HybriQ+ contains a minimum of 20% recycled materials and is manufactured using only renewable energy and 99% recycled water.

Cosentino® CO₂ Neutral

We offset our CO₂ emissions for the entire life cycle of the product.

The ultra-compact Dekton® stone is classified as Carbon Neutral.

We have identified those projects that meet the requirements for responsible offsetting and that, in turn, have a strong social dimension that contribute to the achievement of the Sustainable Development Goals of the UN's 2030 Agenda.

The project chosen in 2019 for the offsetting of CO₂ emissions has an important direct impact on sustainable development by supporting the local economy, providing training and job opportunities.

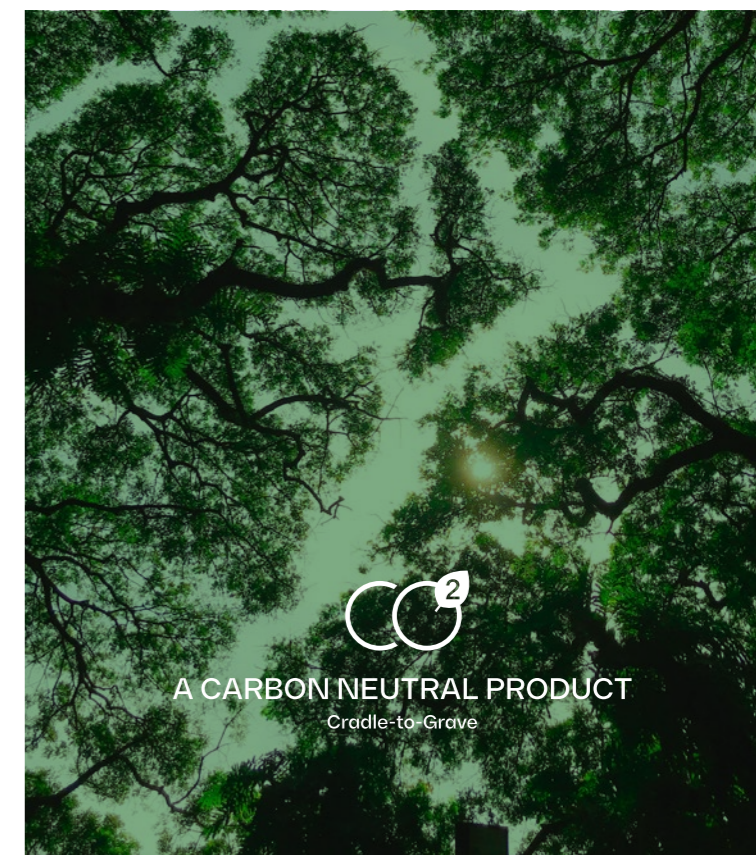

Waste treatment and recovery plant (CoMA)



99% recycled water in all our production processes



Care for the Planet. Restoration of natural spaces in Cantoria, Almeria.



The Bathelier



The Bathelier

by Cosentino®

A unique vision of creative bathrooms.

The Bathelier is Cosentino®'s concept that embodies the vision of a unique, experience-oriented space through renowned designers who interpret bathrooms of the future: unusual, unique and seamless. Iconic spaces with a focus on materials that elevate and redefine bathrooms.

An exclusive portfolio of bathroom solutions, with unique shapes, evocative textures and geometries that combine seamlessly, uniformly and sculpturally. A canvas of colour that transforms bathrooms.

The Bathelier is the result of a creative process that pushes the boundaries of design, generating unique environments that breathe and inspire us. Environments that move us.

REMY
MEIJERS

P. 20

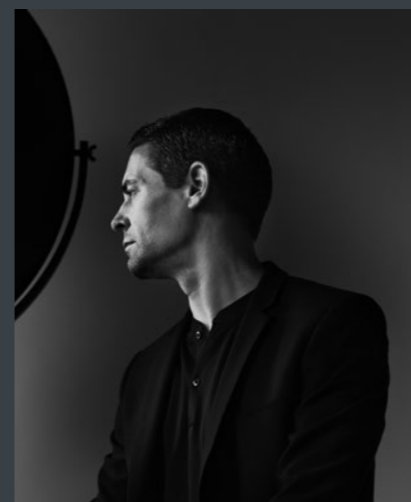

CLAUDIA
AFSHAR

P. 34



DANIEL
GERMANI

P. 48



COLIN
SEAH

P. 62



MUT
DESIGN

P. 76



REMY MEIJERS

X
The Bathelier



“A bathroom should be a space to unwind and clear the mind. It is a place where you start and end your day, so it should be as calm and relaxing as possible. It should also have plenty of room to move around, which is why it is better to refer to it as a bathing space rather than a bathroom.”

In 1995, Remy Meijers graduated with honours from the Department of Interior Architecture and Furniture Design at the Utrecht School of the Arts. In his work, all elements are perfectly in place, but behind the apparent simplicity of his interior designs lies a coherent and comprehensive vision that has been continuously honed over two decades.

Meijers' oeuvre encompasses not only interiors, but also architecture, accessories and furniture. According to Meijers' philosophy, these are not separate elements, but rather complementary parts of an intelligible whole.



Urban Hideaway

by Remy Meijers

Conceived as a set of architectural features that give character to the space, this bathroom has plenty of room for all the elements: a large shower for two, a large wash basin and a spectacular bathtub ideal for bathing.

To complete this spa-like experience, the project features wooden elements for added warmth, a fireplace and an outdoor space with double shower and wash basin. The message is clear: self-care has become a fundamental part of our lives, and your bathroom is at the heart of it.

A large, open space where you can spend time and feel good about yourself. A place to unwind. Without distractions.



Divided into two separate yet complementary parts, one of the most impressive areas in the project is reserved for the bathroom, highlighting the importance of this space in everyday life.

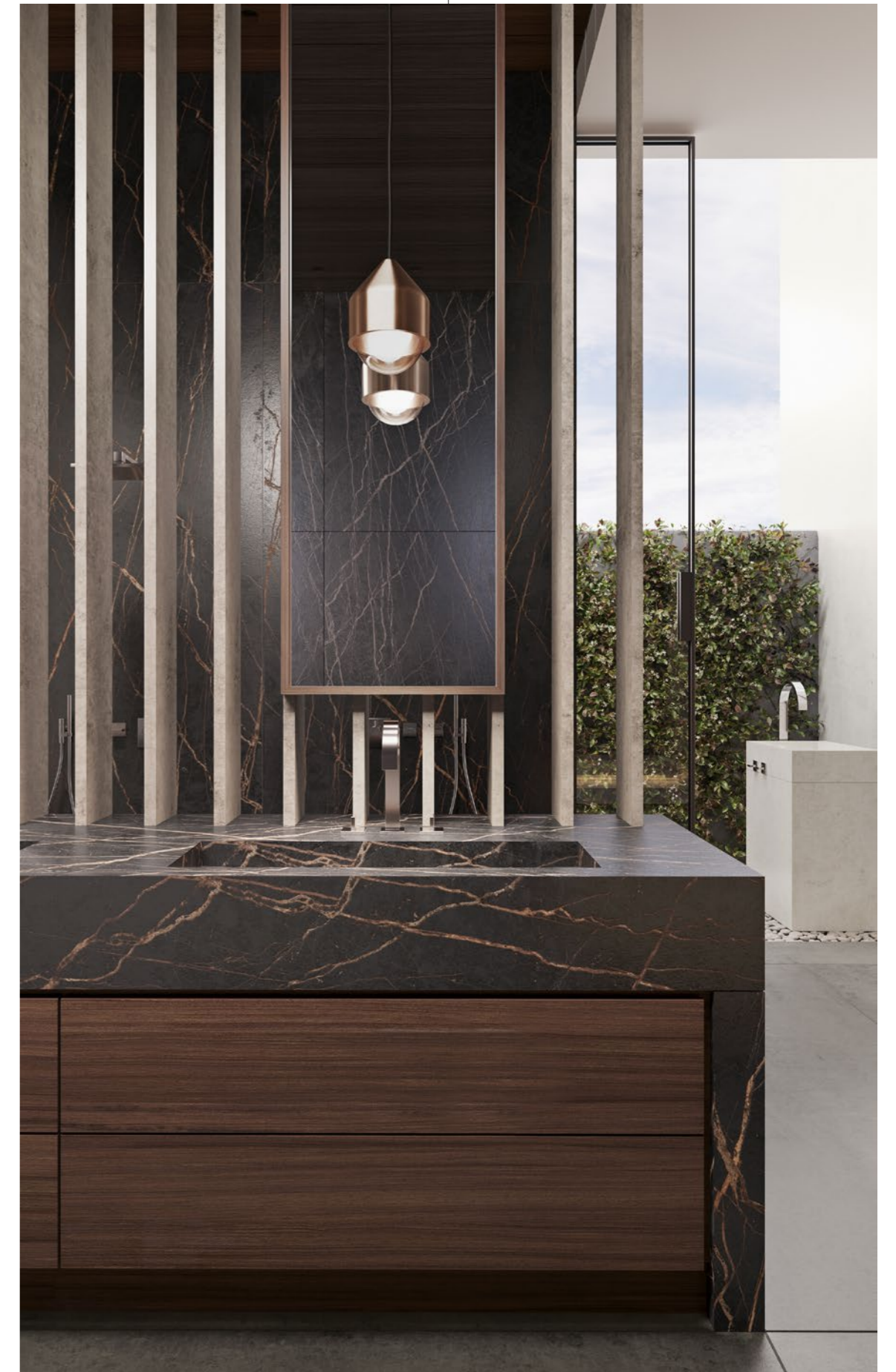

Designed by: Remy Meijers
 Year: 2023
 Wash basin: Reflection S
 Shower tray: Dekton® Rainfloor
 Dekton®: Lunar, Kreta and Laurent
 Decoration: Vases designed by O4Home in collaboration with Remy Meijers



A solid volume presides over the outdoor area, incorporating a wash basin in the form of a fountain that makes the most of the technical performance of the material.

Wash basin: Silence S

Areas connected to the outside, but with plenty of privacy, a large open shower, etc. The designer conceives a space that pushes the boundaries of the bathroom, moving towards new concepts of self-care.





The Palazzo

by Remy Meijers

In contrast to the historic architecture, Remy Meijers uses lightweight, contemporary elements with an essentialist design and straight lines, while retaining original ceilings, doors and windows to add a sense of warmth. An experience that invites you to indulge in the natural fusion of old and new.

The aim of this project is to ensure that the original elements of the space are maintained with an updated approach. To this end, Meijers combines decorative elements, such as the ceiling mouldings and herringbone flooring, with contemporary materials, such as Dekton® and Silestone®, which are used for wash basins and shower trays.



Designed by: Remy Meijers
Year: 2023
Wash basin: Marie Top L
Shower tray: Dekton® Rainfloor
Dekton®: Taga and Rem
Silestone®: White Zeus
Other products: Lamp designed by Keylight
in collaboration with Remy Meijers

The shower area is the centrepiece, dominating the centre of the room. Its raised floor design preserves the original ceiling structure and gives it greater prominence.

A large volume made from Dekton® Rem doubles as a shower tray and is the central feature of the room. Visually connected to the screens through a large glass panel, Meijers suggests an outdoor space for contemplation.



The cladding, wash basin and shower surfaces are a contemporary twist to traditional materials in contrast to the wood and herringbone flooring.



CLAUDIA AFSHAR

X
The Bathelier



“Wellbeing has never been as important in the bathroom as it is today, with functionality and aesthetics playing a key role.”

Based in Los Angeles, Claudia Afshar and her studio have become an international benchmark in the field of interior design. Celebrities and developers worldwide rely on the designer to bring their most emblematic projects to life.

In them she blends stylistic references to the US with hints of the UK and London, her home town, where she began working while learning architectural design at Living Space, her mother's award-winning interior design firm. Her houses, marked by an elegant and contemporary décor, are regularly featured in magazines such as Vogue, Elle Décor and Rue Magazine.



Ananda

by Claudia Afshar

In Hindu, Ānanda means, among other things, 'pure happiness', one of the highest states of human being. Thus, Claudia Afshar has created a striking open plan space that conveys warmth through a design of grooved materials.

She demonstrates the ability of small details to bring a fresh look to bathrooms, with playful accents and textures on all surfaces.

Designed by: Claudia Afshar
Year: 2023
Wash basin: Simplicity
Shower tray: Dekton® Rainfloor
Dekton®: Umber and Nacre



Designed to capture the essence of Dekton®, Claudia Afshar elevates the Simplicity wash basin on a bespoke pedestal in Dekton® Umber, which is grooved as a result of a delicate cutting of the material.





The designer envisions a warm space that embraces the user through the inherent connection with the earth and nature by Dekton® colours Umber and Nacre.



Sawaru

by Claudia Afshar

Touch is one of our fundamental senses for understanding our relationship with the environment. It gives us a nuanced perception of surfaces. With this in mind, Claudia titled her project 'Sawaru', the Japanese word for 'touch'.

A space conceived as a sanctuary, which explores the bathroom as a place of connection and self-care. Sawaru welcomes visitors through an entrance that conveys calm and tranquillity. Light tones and textures combine perfectly with the smooth curves, creating an atmosphere for personal care and complete relaxation. This bathroom offers a dream spa experience.



Designed by: Claudia Afshar
 Year: 2023
 Wash basin: Reflection M
 Shower tray: Dekton® Rainfloor
 Dekton®: TK06 Marmorio and Nacre
 Silestone®: Nolita



Neutral and serene, the interior of this bathroom lies somewhere between the concepts of a personal spa and a homely haven. A recessed arch frames the shower area in the form of a bench, exploring ancestral hygiene rituals from a contemporary perspective.

Claudia experiments with the possibilities of materials, pushing the wash basin to the limit. In this way, by repeating a curved shape, she manages to create a skirt full of volume.

Featuring a minimalist and relaxed design, the entire bathroom project revolves around the relationship between curved and straight lines, generating a leisurely pace that allows you to relax.



DANIEL GERMANI

X
The Bathelier



“A visually appealing space is no longer enough to satisfy people. Their needs and behaviours are key to creating an engaging and holistic experience and, more importantly, for wellbeing to flourish.”

After graduating in architecture in his native Argentina, Daniel Germani spent almost a decade in Europe working on different creative and business projects. A highly innovative vision of design has seen him work as a creative director and designer for some of the world's most inspiring companies.

His multi-disciplinary studio, specialising in product design, design consultancy, interior design and architectural renovation, is based in Phoenix, Arizona, but Daniel travels around the world doing design work in partnership with leading global brands. His rationalist yet distinctive style is clearly influenced by the modern and Bauhaus movements. Its philosophy is simple: good design should always be honest and inspiring.



Ceppo

by Daniel Germani

In this project, Germani develops two separate vanity areas to adapt to the different needs of the users of the space. At the same time, it creates a more pleasant and playful feeling in the shower and bath area. The space maintains a balanced effect of personal sanctuary, where small daily rituals of self-care are explored as a way of enhancing wellbeing.

With a deep respect for the materials, Germani achieves a calm and serene space of large dimensions, in which the bathroom stands out as the centrepiece of the home.

Designed by: Daniel Germani
Year: 2023
Wash basin: Silence M
Shower tray: Dekton® Rainfloor
Dekton®: GK07 Ceppo
Taps: Taps from Sailing collection by Fantini





The brutalist feel of the cladding, which echoes the traditional Ceppo di Gré stone from Lombardy, highlights the subtle, warm design accents throughout the space. It includes two large wash basin areas designed with Dekton® due to its high performance: resistance to stains, scratches, knocks, etc.

The Silence wash basin lives up to its name, providing a relaxed look and subtle lines. In combination with the Ceppo series from Dekton®'s new Pietra Kode collection, it underlines the timelessness of the materials used in the space.





Travertino

by Daniel Germani

Contemporary, intimate and sophisticated features make up a balanced project. Two walnut vanity units and a shelf provide additional storage space, allowing you to discreetly store toiletries or decorative items.



The view of the courtyard with its greenery is a peaceful oasis for relaxation. The shower, which is in a separate area, is a way of escaping from everyday life through the ritual of water. In this project, Germani transports us to Rome in all its glory.



The result is a clean and serene bathroom, which embraces the experience of light flooding the space. This water room reclaims a leading role that explores ancient bathing rituals from an updated perspective.

By creating a sensitive blend between indoors and outdoors, Germani recreates a space for self-contemplation that goes beyond the traditional boundaries of bathrooms.

The project addresses several strategies that, when approached in a specific way, complement each other to give a complete turnaround to a bathroom, transforming it into a more open and flexible residential space that breaks with conventions.

Designed by: Daniel Germani
Year: 2023
Wash basin: Silence M
Shower tray: Dekton® Rainfloor
Dekton®: TK06 Marmorio and TK05 Sabbia
Taps: taps from Icona Classic collection by Fantini

COLIN SEAH

X
The Bathelier



“The ideal bathroom is a sanctuary for holistic wellness, where body and mind are cleansed and nourished. Away from the hustle and bustle and distractions of the world around us, it offers a moment to immerse ourselves in healing sounds, aromas and textures.”

Colin Seah trained as an architect in the USA, but today he is the Design Director and founder of the Singapore-based studio Ministry of Design (MOD). His radically innovative approach to design and architecture leads him to question conventions and redefine spaces in every project.

Beyond spaces, Seah creates physical reflections on how design can act as a catalyst for change. He has overseen over 100 projects worldwide and has received numerous awards, including 'Designer of the Year' by the International Design Awards USA (2010) and 'Rising Star in Architecture' by Monocle.



The Collage

by Colin Seah

In life, as in art, we seek balance and harmony when its complexities threaten to pull us in different directions.

The Collage strikes a balance between a range of different and even contrasting colours to create a unique moment of holistic harmony. The inherent beauty and challenge of a collage is to achieve an "elusive balance". When this is achieved, the whole magically becomes more than the sum of its parts.



The Simplicity wash basin fits into a large volume, featuring a benchtop that takes advantage of the large dimensions of Silestone® materials to build an extra long surface to adapt to the space.



Chaos and order are the two cornerstones of Seah's project.

A bathroom space that explores the diversity of nature and the mix of materials, generating a collage that integrates the elements of the shower tray, in combination with the cladding, and the wash basin.

Designed by: Colin Seah
Year: 2023
Wash basin: Simplicity
Shower tray: Rainfloor
Dekton®: Soke and Laurent
Silestone®: Et Serena
and Ethereal Noctis



The Cave

by Colin Seah

Personal hygiene and bathing habits are undeniably primitive and fundamental to human beings. From this premise, Colin Seah explores a space reminiscent of a cave and introduces us to a primitive way of relating to the place in which we live.

In this design, rituals come to life through the creation of a dramatic bathroom, characterised by sloping walls in deep earth tones, integrated lighting and a huge window at the back. This bathroom also reminds us of the most primitive form of architecture: the cave.



Designed by: Colin Seah
 Year: 2023
 Wash basin: Simplicity
 Shower tray: Dekton® Rainfloor
 Dekton®: Bromo, Laurent
 and Awake
 Silestone®: Coral Clay Colour
 and Sienna Ridge
 Decoration: Gessi



The volume of the wash basin, made with the Reflection model integrated with Dekton® Laurent, recreates an almost mystical atmosphere. In the same way as an altar, this object elevates the moment of contact with water to a ritual, reflecting bathrooms have become an essential space for self-care and health.

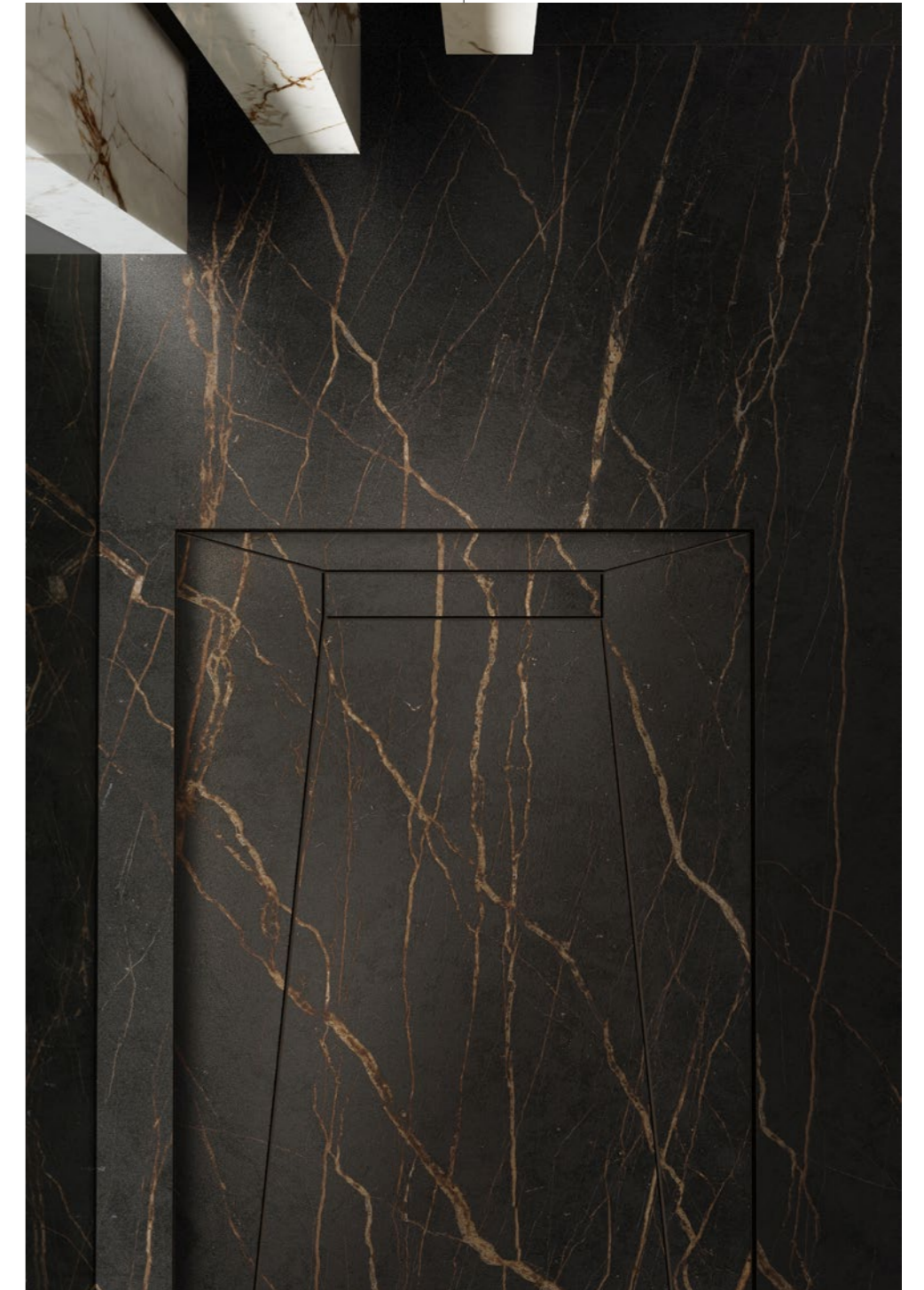

An opening in the façade frames a privileged view of the exterior and floods the interior with plenty of natural light. This impressive area is reserved for the shower tray, making this moment a unique experience.

MUT DESIGN

X
The Bathelier



“Reconnecting with our body and mind to reach the ideal of healthy living has become a fundamental part of how we overcome stress in our lives. For us, a bathroom is that private, safe haven where this dialogue takes place.”

Specialising in product design, Alberto Sánchez and Eduardo Villalón are the design duo behind MUT Design, one of the leading studios on the international design scene and clear representatives of the new wave of Valencian designers. Since it was founded in 2010, MUT Design has received continuous recognition at major industry awards.

Its thoroughly contemporary style is a perfect balance between an essentialist design and a careful selection of materials and finishes. Today they are among the most popular and renowned designers of their generation and have collaborated with some of the most inspiring brands in design.



The Resilient House

by MUT Design

A home is as essential as a roof and four walls to shelter us, but above all it is the place that gives us the privacy and freedom we need to connect with ourselves, rethink our lifestyle and value wellbeing. Based on this premise, MUT Design suggests a space inspired by a kind of Roman bath in ruins enclosed by the walls of a quarry, alluding to the origin of Cosentino®.



As an interior architecture programme, MUT Design makes use of a series of volumes with Dekton® to create hollows in the space, completed with a bathtub and a wash basin where the Simplicity model is integrated. This project proves the material's ability to adapt to any type of surface and functional solution.



A completely uniform range of materials makes for a minimalist and serene space, interrupted only by the natural stone that features in certain areas. The contrast highlights the combination of materials, thus elevating the presence of both.



Designed by: MUT Design
Year: 2023
Wash basin: Silence L
Shower tray: Dekton® Rainfloor
Dekton®: Nacre



Ellipse

by MUT Design

In this project, MUT Design is inspired by the expressionism and organic architecture of Torres Blancas in Madrid. The curved, spiral and seashell shapes so often found in nature are used here as an expression to convey emotions through shapes and textures.

It is a space that serves not only as a formal experiment but also as a functional one. To achieve this, a partitioning element plays with the different levels of privacy in an open bathroom space formed by using truncated cylindrical modules. These facilitate the flow from inside to outside and vice versa, and also explore new ways of understanding this room as a fundamental part of today's home.



Designed by: MUT Design
Year: 2023
Wash basin: HLine Urban
Shower tray: Dekton® Rainfloor
Dekton®: VK02 Avorio and Argentium
Furniture: Sancal chair by MUT Design

Different spaces are generated through the volumes, playing with the levels of privacy of an open-plan bathroom. Using the same slat construction system, the HLine Urban wash basin is housed in a pedestal.

A shower area is concealed behind the cylindrical element, ensuring privacy while also being directly connected to the large exterior window.



State of the art technology and innovative design for your bathroom. Beauty and functionality for a customised space.

At Cosentino® we have developed a wide collection of surfaces and features for bathrooms. From wall and floor claddings in different yet perfectly balanced formats, colours and textures, to attractive wash basins and shower trays, carefully designed with great attention to detail and simplicity.

Change your vision of bathrooms. An all-round solution of high aesthetic and functional value to turn your bathroom into a complete experience of wellbeing and visual comfort.



The avant-garde design and the quality of Cosentino® materials merge in timeless bathrooms made to be lived in.

Atmospheres designed by Cosentino® in which quality, sophistication and a holistic view of the space are paramount. Inspiration and solutions for any decorative style that will help you find your ideal bathroom thanks to Cosentino®'s extensive portfolio of materials and products.

From industrial character to Mediterranean simplicity. A wide range of spaces rich in details and finishes to connect with any style.

Mediterranean



Classic



Industrial



Timeless





In this bathroom with a pure design and straight lines, natural light takes on a material dimension.

The play of light and shadow accentuates the contrast created by the subtle combination of two very similar, but at the same time very different Dekton® colours: VK03 Grigio, a colour inspired by Grigio Alpi natural stone, and VK04 Grafite, a colour that reinterprets dark limestone. The difference in colour between these two shades of grey helps to create deliberate contrasts between light and dark, as in the lintels of the window arches

or in the transition space between the water area and the bedroom. VK04 Grafite also helps to accentuate the powerful beauty of the Reflection wash basin by enclosing it in a monolithic pedestal with a freestanding tap. The almost zero porosity of Dekton® ensures that this design will remain unaltered over time. The same applies to the Exelis shower tray, which is made from Silestone®.



Silestone® Exelis



Dekton® Reflection S



Dekton® VK03 Grigio

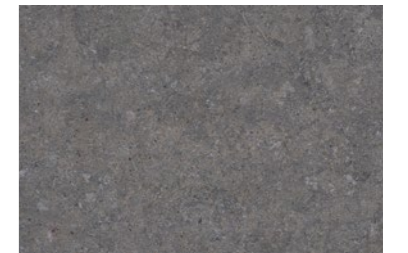

Dekton® VK04 Grafite



Dekton® TK06 Marmorio



Dekton® TK05 Sabbia



Silestone® Exelis



Dekton® Silence S



Inspired by the timeless beauty of Travertine marble, this bathroom reinterprets the concept of Roman baths to create a modern space with relaxed lines.

Thanks to the use of two totally different patterns based on the same stone, the sense of spaciousness is enhanced. The colour chosen for the walls was Dekton® TK06 Marmorio, a recoding of Travertino Navona, the stone out of which ancient Rome was built. Its distinctive parallel lines add solemnity to the entire area. As for the flooring and wash basin area, the colour chosen was Dekton® TK05 Sabbia, a stylised version of Travertine

characterised by a strong horizontality and veining that maximises the expressiveness of natural stone while ensuring the highest performance of ultra-compact stone. TK05 Sabbia was also used for the Silence wash basin, achieving total integration, while the simplicity of Silestone® Exelis was chosen for the shower tray.



The stone that has shaped contemporary Milan has become one of the main trends in decoration.

Both residential and commercial spaces pay tribute to the beauty of Ceppo di Gré, whose playful structure features large, attractive grey and blue patches.



Dekton® GK07 Ceppo

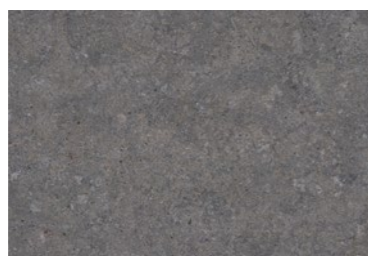

Dekton® VK04 Grafite



Silestone® Exelis



Silestone® Marie TOP L

The new GK07 Ceppo redefines this beautiful pattern to give it greater visual strength and the technical features of the ultra-compact Dekton® stone. Large format slabs allow for a more seamless design, with fewer joints. This finish, used on floors and skirting boards, is combined with VK04 Grafite, another of the colours from Dekton®'s new collection, Pietra Kode. To create a contrast with the stone tones, two Silestone® designs were chosen: the shower tray features the Exelis model, while the Marie TOP L was the model chosen for the benchtop wash basin.





Dekton® VK03 Grigio



Dekton® VK01 Nebbia



Silestone® Exelis



Dekton® Silence L



The simplicity of Vicenza stone and the purity of Dekton®'s large format design come together in VK03 Grigio and VK01 Nebbia.

Both contribute to creating a Japandi-style bathroom where the warmth of the rich taupe grey range of VK03 Grigio combines with the wooden elements and creates a contrast with the creamy base dotted with spots of VK01 Nebbia, the colour used for the benchtop and

the integrated Dekton® Silence wash basin. The shower tray features the Exelis model by Silestone®, in large format. This surface has very low porosity, which reduces daily maintenance and improves hygiene in bathrooms.



Dekton® VK01 Nebbia



Dekton® VK04 Grafite



Silestone® Exelis



Dekton® Reflection L



Nature is very present in this bathroom that opens onto an interior garden and features a combination of materials and textures in neutral tones.

Cobining wood and rattan design elements, Silestone® and Dekton® surfaces blend seamlessly into the overall design. The space features VK01 Nebbia on walls and floors, bringing a calm and classic touch with its texture inspired by Italian Vicenza stone.

This light grey tone is combined with the deep Dekton® VK04 Grafite, which was used for the Dekton® Reflection wash basin and the floors in the wet area. Its dark background features a pattern that creates a sense of continuity while reinterpreting the texture of limestone. The perfect frame for the Silestone® Exelis shower tray.



Modern and elegant, this bathroom presents a space in which straight lines take centre stage.

The balance between the forms creates a sculptural atmosphere featuring a two-colour combination that spans a wide range of greys and blacks. In this composition, both Silestone® Charcoal Soapstone and Dekton® Kreta have an equal role.

Used on floors, walls and bathtub cladding, the texture of Dekton® Kreta adds depth and creates a greater sense of spaciousness thanks to its light tone inspired by classic cement floors. Meanwhile, Silestone® Charcoal Soapstone gives the wash basin benchtop a dramatic effect, adding an elegant touch. Silestone® Marie TOP L wash basins add a touch of finesse with their rounded corners. Finally, the shower tray features the Rainfloor model by Dekton®, perfectly integrated thanks to the use, once again, of Dekton® Kreta.

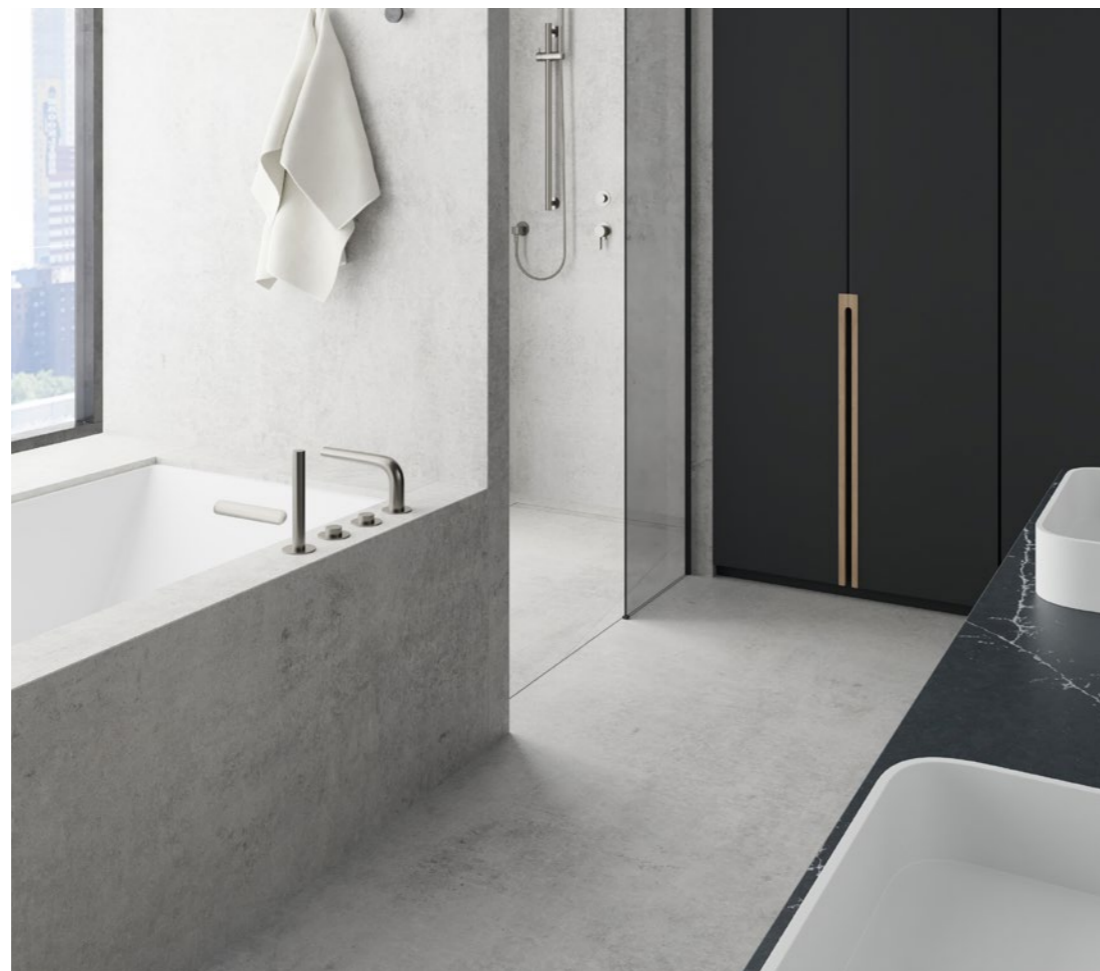

Silestone® Charcoal Soapstone

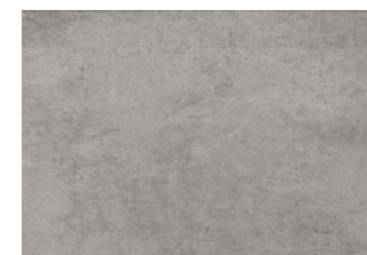

Dekton® Kreta



Dekton® Rainfloor



Silestone® Marie TOP L

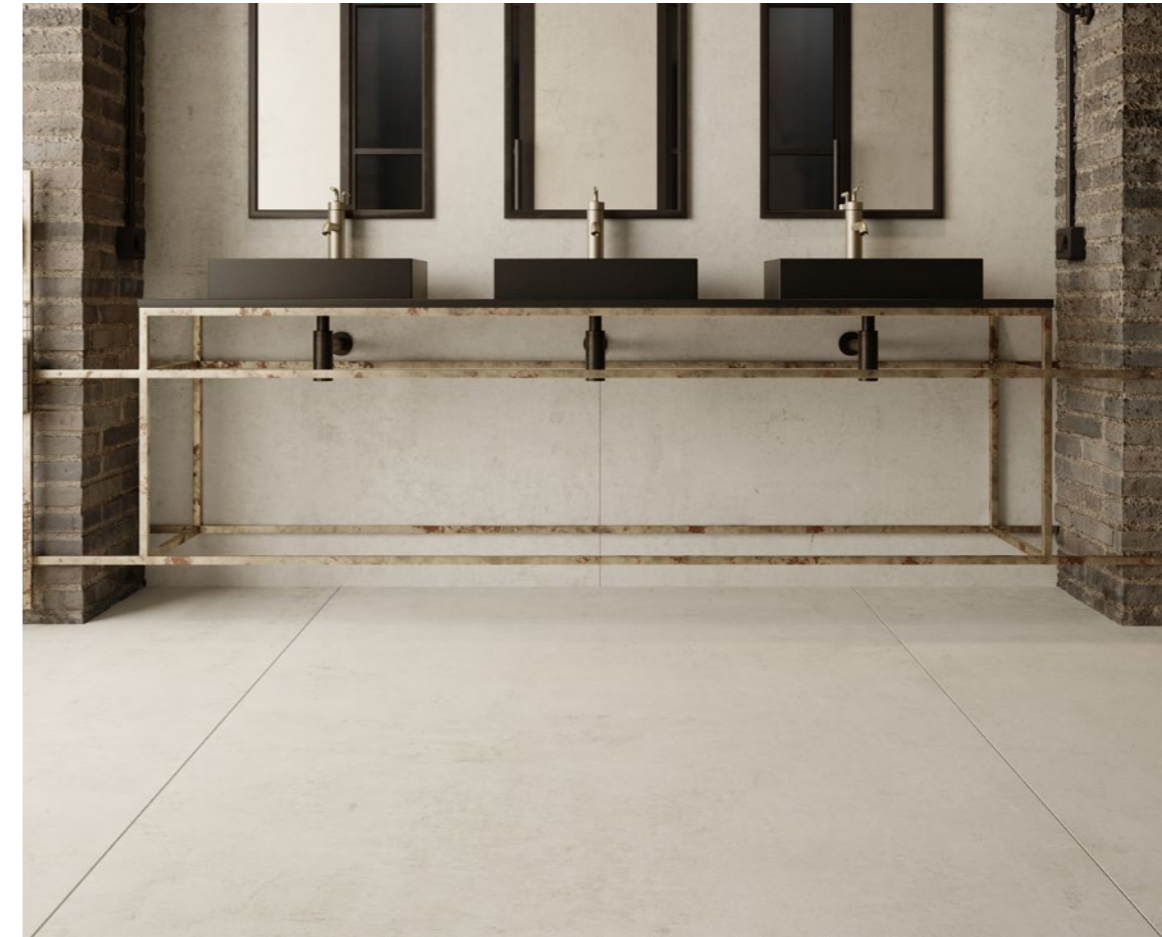

Dekton® Blanc Concrete



Silestone® Negro Tebas

This bathroom with a renewed industrial style combines metal elements, wooden beams and exposed brick with innovative Cosentino® surfaces.



Silestone® Symmetry M



The ecru shade of Dekton® Blanc Concrete aged white fits perfectly with this decorative style. Its spots and small veins in shades of white and beige make the space look bigger and enhance the natural light flooding in through the large windows.

To create a contrast, the surface chosen for the benchtop and the three wash basins with their simple lines and geometrical look was the pristine, glossy Silestone® Negro Tebas. Supported by a lightweight, aged metal frame and complemented by three large, dark-framed mirrors, together they create a balanced and captivating bathroom.

Monolithic forms give character to this temple-like bathroom, in which textures inspired by natural stone establish a link with the surrounding landscape, which is connected to the bathroom through floor-to-ceiling openings.

Dekton® Fossil, a colour featuring a very powerful natural finish with the aged look typical of fossilised stones, was the material chosen for both the benchtop and the floor. To match this natural texture, Dekton® Taga, an elegant grey shade with a marbled look inspired by Taj Mahal quartzite, was the material chosen to clad the walls.



The design of the wash basin is undoubtedly the star of this space. The Custom Wash basin in Silestone® Negro Tebas is mounted on a horizontal base that runs through the space and counterbalances the verticality of the other elements.

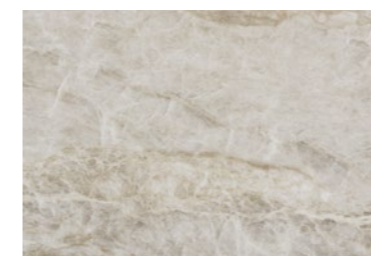

Dekton® Taga

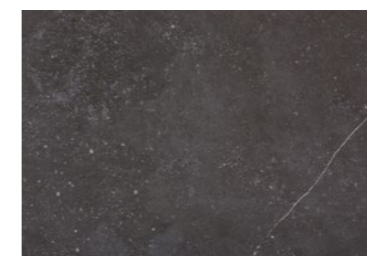

Dekton® Fossil



Silestone® Negro Tebas

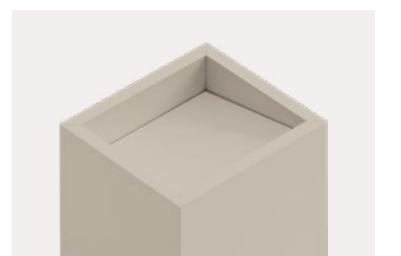

Custom Wash basin



A uniform and elegant look characterises the style of this contemporary bathroom in which order is expressed through the materials used.

Straight lines dominate the space, accentuated by the minimalist design of all the elements and, more specifically, of the Dekton® Simplicity wash basins. To create a block-like feel, a sense of unity, a single Dekton® colour was chosen for walls, floors and wash basins.

Specifically, the colour chosen was Dekton® Sogne, which gives a neutral feel to the space. Its grey shade ranges from the classic cement textures to the typical veining of natural stone, helping to create an atmosphere that breaks the boundaries between the industrial and the classic. It is an architectural design complemented by black taps and backlit mirrors, adding dynamism to the space.



Dekton® Sogne



Dekton® Simplicity



Silestone® Marie TOP L



Dekton® Rainfloor

The updated classic style of this luxurious bathroom is expressed in every detail.



Dekton® Awake



Dekton® Nacre



The use of light, neutral colours, contemporary touches such as black taps and a sophisticated texture inspired by natural stone create a space that exudes a quiet elegance. To maximise the light, the surfaces, furniture and Marie TOP L wash basins feature light colours.

Used on the wash basin area, floor and walls, Dekton® Awake shines in its own light and elevates the tone of the entire room. Its design inspired by Paonazzo stone

provides an elevated look with its thick veins in shades of light grey, terracotta cream and subtle blues. To define the wet area, such as the bathtub and shower – perfectly integrated thanks to the use of Dekton® Rainfloor–, the colour chosen was Dekton® Nacre, a more neutral tone that contributes to creating a truly relaxed space.



A combination of black and white dominates this urban style bathroom with city views.

The elegance in this bathroom comes from the elevated design pieces used, such as the golden taps, the black freestanding bathtub and the striking front vanity unit supporting the geometrically shaped Dekton® Silence wash basins.



These elements create a link with the contemporary feel of Dekton® Neural, whose design provides a strong sense of continuity. Fine, pale veins run through its marbled background in light cream tones, creating an enveloping effect.

To create contrast and separate the different spaces, the walls of the shower area – which features a Silestone® Exelis shower tray –, are clad in Dekton® Somnia, a black colour with brown and white veins.



Dekton® Neural

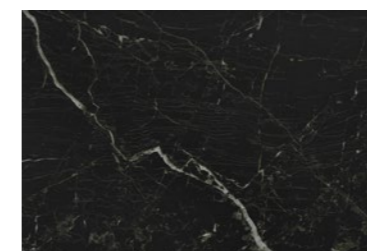

Dekton® Somnia



Silestone® Exelis



Dekton® Silence M





Dekton® Nacre



Dekton® Umber



Dekton® Rainfloor



Silestone® Integrity Evita L

The simplicity of this rustic Mediterranean bathroom design is made clear in every aspect.

The harmony and commitment to tradition is evident in every aspect of this bathroom, from its vernacular architecture to its natural materials and finishes. To create this vibrant atmosphere, a combination of two warm colours was used on the walls and floors. Both reflect innovation and, at the same time, fit in perfectly with the style.



The powerful terracotta shade of Dekton® Umber is this space's star feature. Alongside this colour, the cream tone of Dekton® Nacre – a colour with a texture similar to that of lime plastering and featuring subtle details and a degraded texture – was also used, bringing authenticity and character to the space, creating a contrast and establishing a link with Umber. The Silestone® Evita – Integrity wash basins blend subtly and discreetly into the space. In the shower area, clad in Dekton® Nacre, the use of a Dekton® Rainfloor shower tray provides continuity to the room.



Dekton® Eter



Silestone® Symmetry S

This minimalist, monochrome bathroom goes for all black.



The combination of eclectic elements, such as a classic style mirror and a contemporary vanity featuring a Silestone® Symmetry wash basin, is rounded off by the careful choice of this colour, creating a sensorial and deep space. The result is a quiet atmosphere, conceived to create a cosy private area, totally innovative.

To achieve this sense of uniformity and to create a perfect black space for the design elements, Dekton® Eter was chosen. Its dark granite structure in black and grey tones gives this surface a rich and complex texture, perfect for creating such contemporary atmospheres like this trendy bathroom.



Silestone® Blanco Zeus



Dekton® Helena 22



Silestone® Marie TOP L



Silestone® Kador Suite

The quietness of white is broken and enhanced by an elegant combination of textures and finishes in this contemporary bathroom.



There is a calm and, at the same time, very elegant atmosphere thanks to the many bronze details, such as the alcove frames, round mirrors and taps. In addition, two Cosentino® surfaces were chosen to elevate the design of the room: Silestone® and Dekton®.

The pure and neat texture of Silestone® White Zeus was chosen for the cladding of the floors, the benchtop, the wash basin - featuring the rounded design Silestone® Marie TOP L-, the Silestone® Kador shower tray with anti-slip strips, and

one of the walls. For all applications, a glossy, light-reflecting finish was chosen, creating a perfect blend with the fine crackle effect of Dekton® Helena, the colour used for the front of the wash basin unit and the rest of the walls in the room. This rich colour featuring a combination of white and grey shades with patterns inspired by Onix natural stone, elevates the design, adding elegance and sophistication.

Projects

Re-imagine the most personal space in your home. Create a unique experience in which the most beautiful and functional Cosentino® surfaces are transformed into unique, warm and exclusive spaces.

From wall and floor claddings in different yet perfectly balanced formats, colours and textures, to attractive wash basins and shower trays, carefully designed with great attention to detail and simplicity. Solutions of great aesthetic and functional value to suit every requirement and style of bathroom, which redefine the way in which we experience such a personal space and feeling of well-being .



Villa Hartl / Promenade, Austria



Casa Contreras La Ventana

Mexico City, Mexico

A balanced design using
Dekton® in a luxury
home in Mexico City



Dekton® Opera



U Interior Design Casa Decor 2022

Madrid, Spain

A bathroom combining modernity and classical design inspired by early 20th century Paris and reminiscent of the Art Deco style, the space features Jacob Delafon's 'Grand Boulevards' bathroom collection.



Dekton® Awake





J'aime tout chez toi

Paris, France

Studio Costa Molinos
turns to Dekton® for the
innovative vanity unit in the
home of French influencers
J'aime tout chez toi.

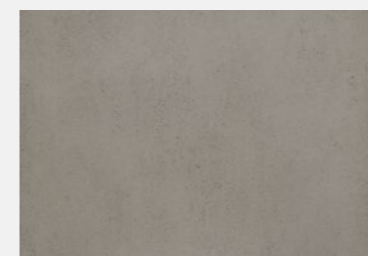
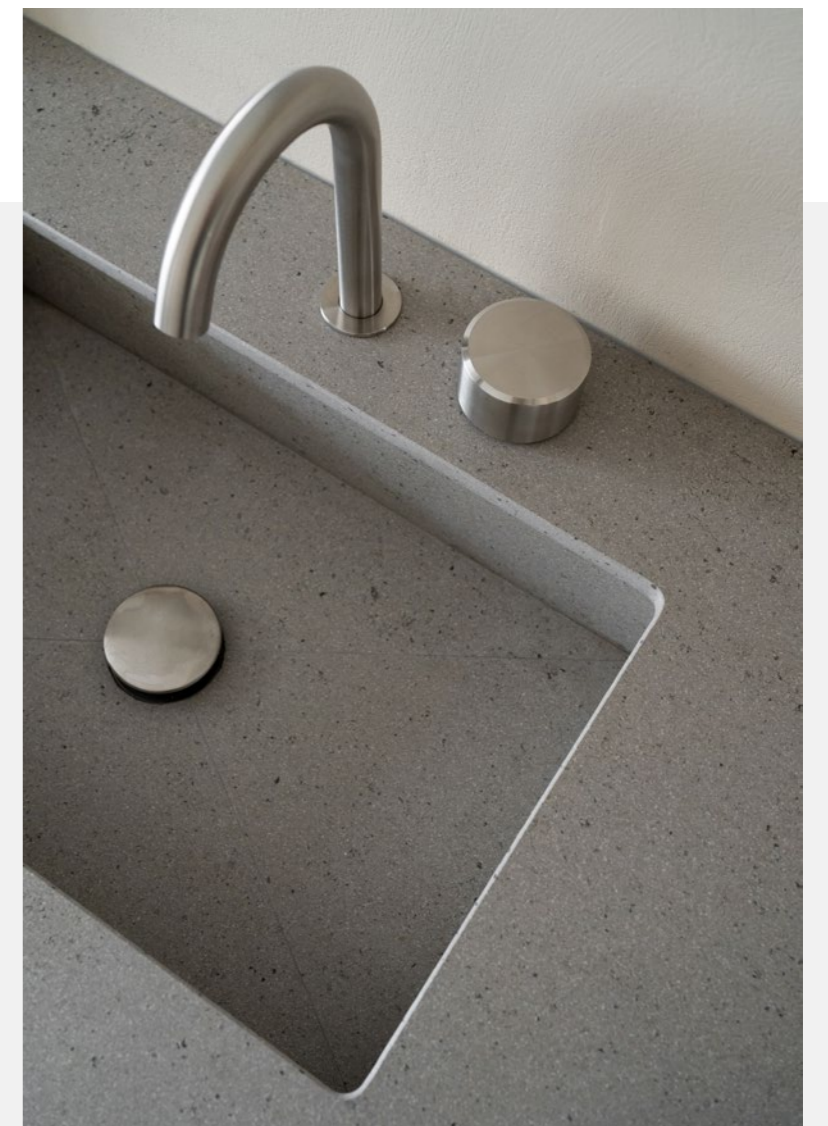

Dekton® Strato

Detached house

Seville, Spain

The bathrooms in the house have been designed as true luxury spaces that also act as a spa.

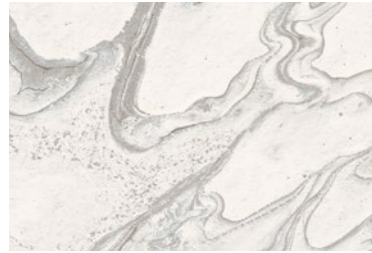

Dekton® Liquid Sky 22





Apartment in Tel Aviv

Tel Aviv, Israel

A total look in Dekton® Opera for a feeling of spaciousness in the main bathroom, while at the same time conveying a sense of grandeur.



Dekton® Opera





Silestone® Pearl Jasmine

North House

Melbourne, Australia

The bathroom spaces in this house are both modern and timeless and, above all, very attractive.

The bathroom furniture is wall mounted to create a clean, floating visual effect.





Art House in Dallas

Dallas, Texas, USA

Dekton® Dancæ is reminiscent of sand moving in the desert thanks to the different shades of beige that cross its surface and capture the essence of the movement.

Inspired by the quartzite of the Taj Mahal, Dekton® Arga, from the Stonika collection, recreates the luxury of natural stone with no maintenance required.



Dekton® Dancæ



Dekton® Arga





Home in R o Claro

R o Claro, S o Paulo, Brazil

The bathrooms are designed to the millimetre, combining benchtops with lacquered wooden doors, designer handles and wallpaper.

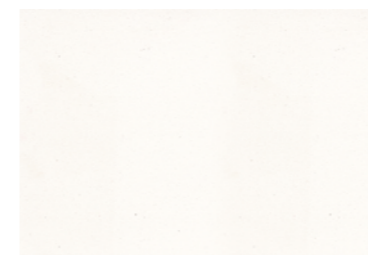
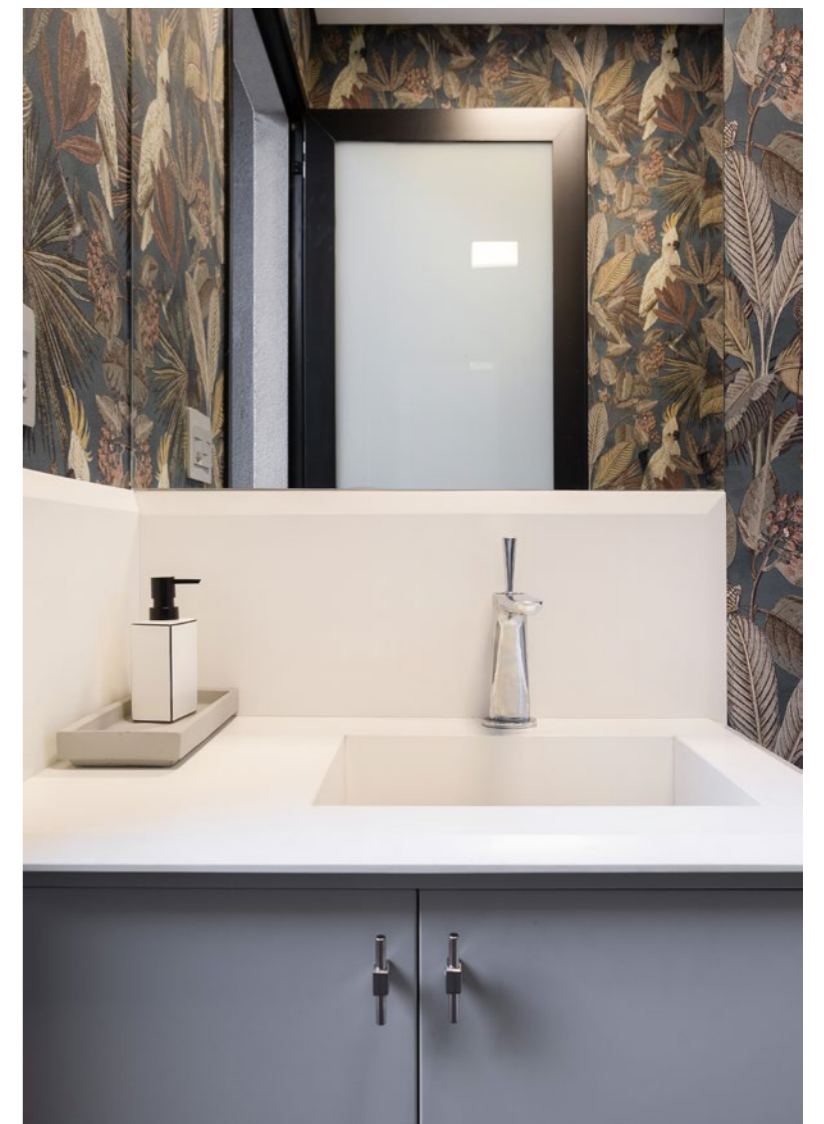

Silestone® White Zeus



Silestone® Noka



Girasol building

Madrid, Spain

A range of dark tones that dominate the bathrooms, which are made entirely in Silestone® Eternal Noir or in a combination of Dekton® Eter and Silestone® Charcoal Soapstone.



Silestone® Marie TOP L

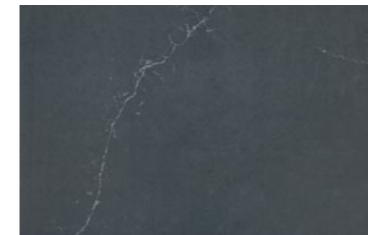

Silestone® Charcoal Soapstone

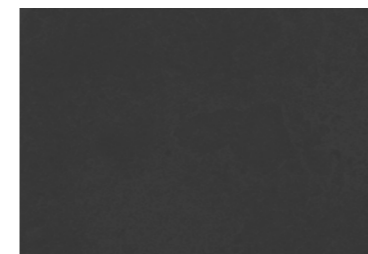

Dekton® Eter

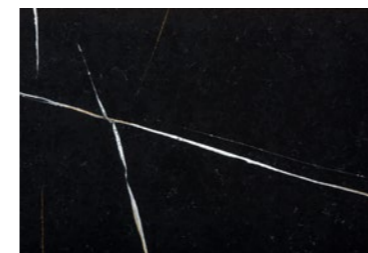

Silestone® Eternal Noir



Silestone® Symmetry

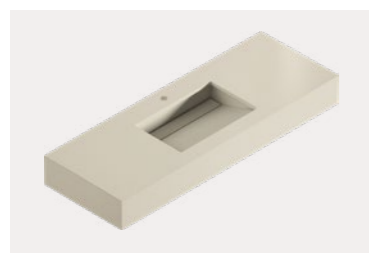

Silestone® Simplicity



Dekton® Portum

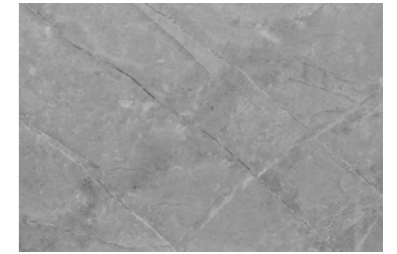

Dekton® Vera

Amble Green Residence

Canada

The bathroom spaces in this house are the ultimate definition of relaxation and elegance.

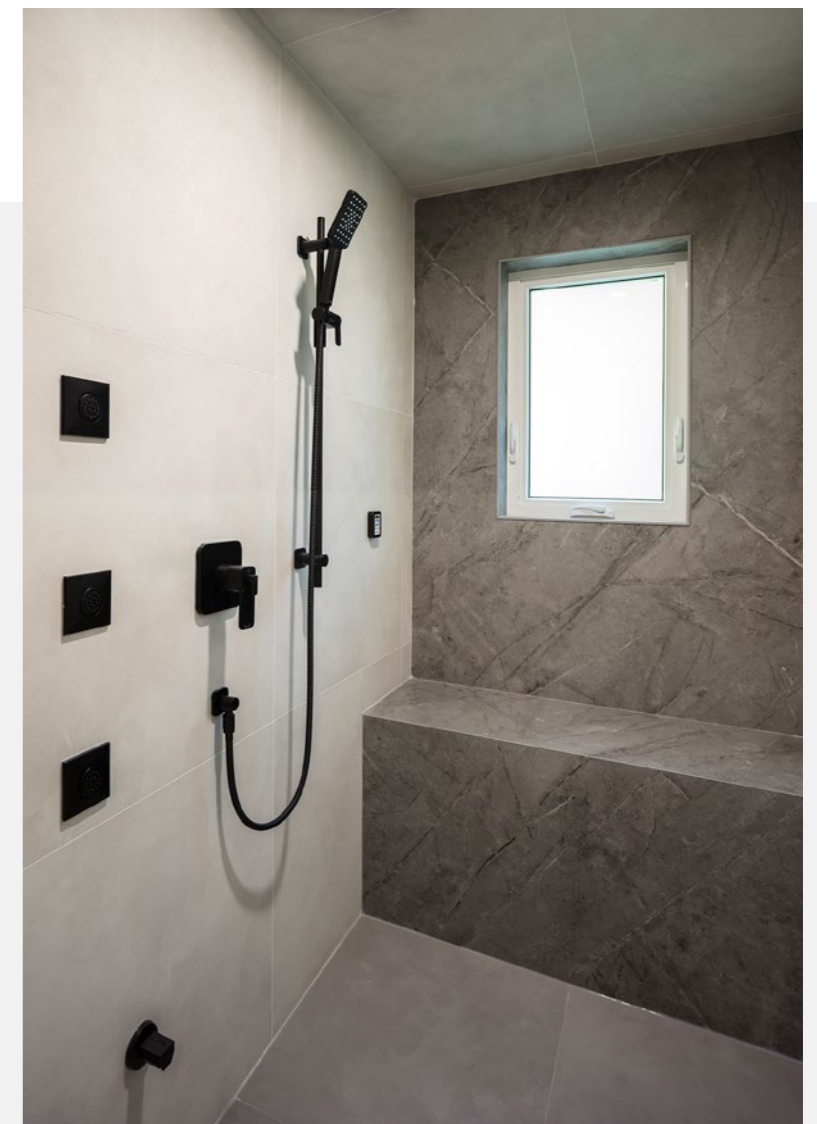

Design Zage

Singapore

By combining style and functionality, Dekton® Bergen creates a sophisticated and timeless atmosphere in the master bathroom.

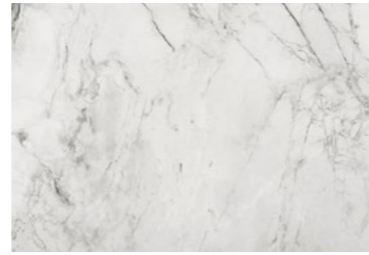

Dekton® Bergen

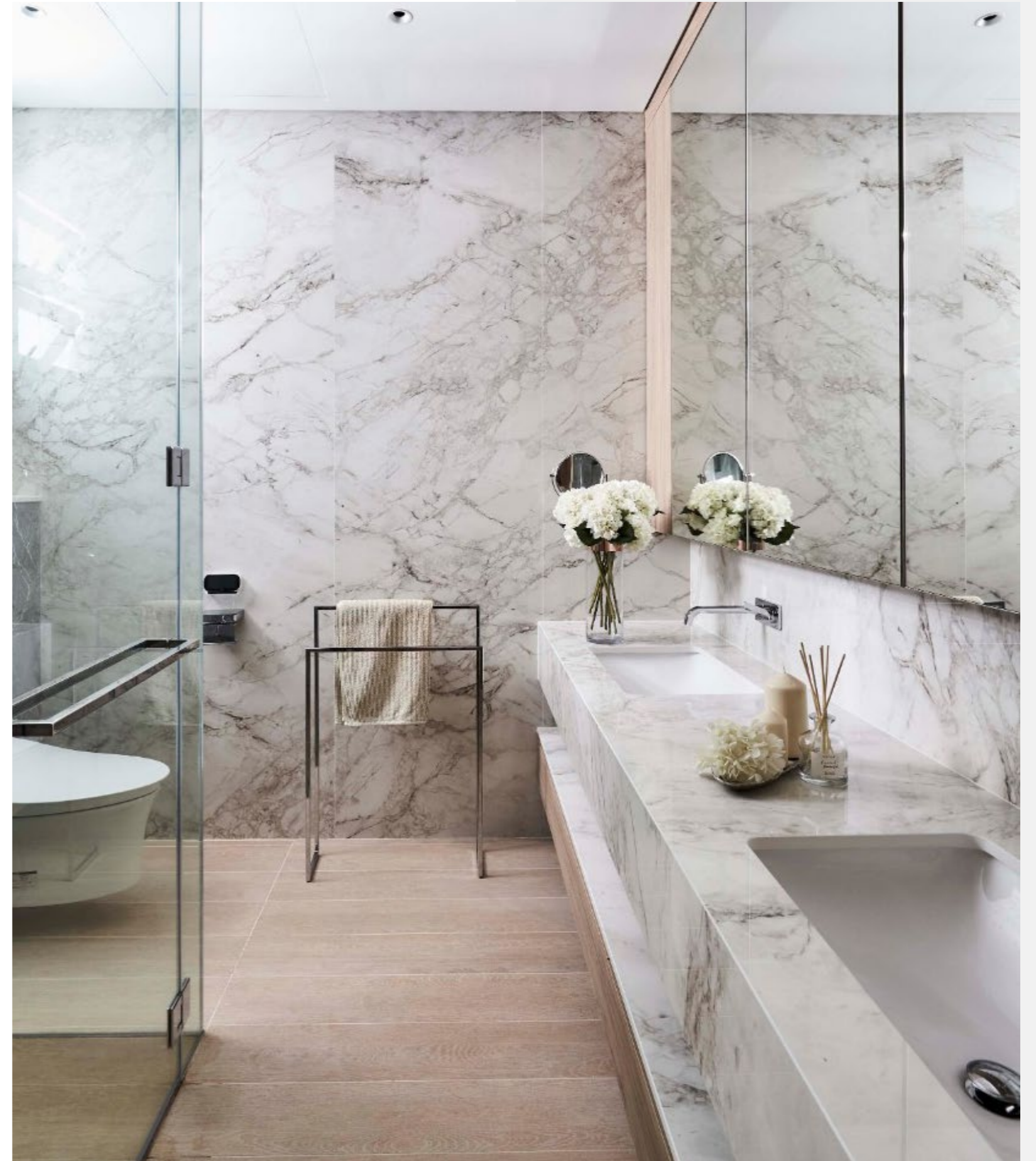



Apartment in Tel Aviv

Tel Aviv, Israel

Dekton® Laurent was the surface chosen for the master bathroom, a colour that provides quite a masculine look. As for the guest bathroom, the colour chosen was the warm Dekton® Liquid Shell, which was used in combination with Dekton® Aeris for the floors.



Dekton® Aeris



Dekton® Liquid Shell



Dekton® Laurent

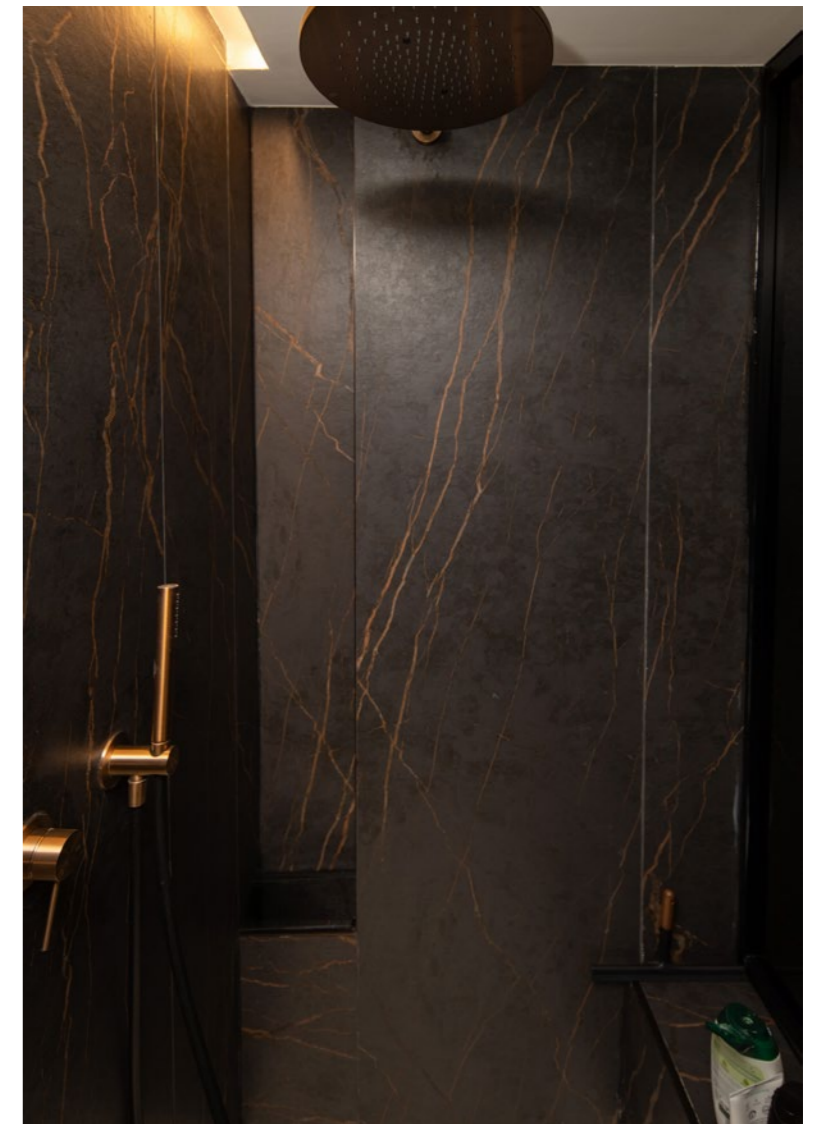



Dekton® Lunar



Dekton® Kreta



Dekton® Kelya



Home in Pradejón

La Rioja, Spain

For the cladding of wet areas, the large format model was used to minimise the number of joints, which are always vertical. This helps in terms of functionality and gives it a more attractive appearance.



Overall bathroom concept



Flooring and cladding

Possibility to combine wash basins and shower trays with all Silestone®, Dekton® and Sensa surfaces and their wide variety of formats and finishes.



Wash basins and benchtops

Wash basins and benchtops in different Dekton® and Silestone® finishes, which allow them to be combined with the rest of the bathroom elements.



Shower trays

Made of Dekton® Grip/Grip+ and Silestone® sandblast, our wash basins and shower trays can be customised to any space.



How do we make it?

Custom design

All our products are manufactured to order using fast manufacturing systems. This allows us to offer a tailor-made design for each client.



Total integration

Visual and aesthetic continuity. The same surface for all of your bathroom: floor, cladding, shower tray, wash basin, benchtop...



Variety of formats, colours and textures

Cladding and flooring in different formats, colours and textures in perfect balance with Silestone®, Dekton® and Sensa materials.



Large format

Fewer joints ensure greater cleanliness and hygiene. The extra-large slabs give a sense of spaciousness.



Materials

The state of the art materials developed by Cosentino® bring unique, warm and avant-garde spaces to life.

The high performance and the variety of formats, colours and textures of Cosentino®'s materials allow for countless design possibilities. Silestone®, Dekton® and Sensa contribute to the design of visually uniform spaces that seamlessly integrate all features: floors, cladding and furniture, wash basins, benchtops and shower trays.

Innovative materials that inspire the design of the future and create exclusive bathroom spaces in which beauty and functionality go hand in hand.



Dekton®. The Ultra-compact Stone.

25
Year
Warranty
DEKTON®

Dekton® is an ultra-compact stone that takes inspiration from the beauty and processes of nature and reinterprets them through unique technology.

Dekton® is functional beauty in a high performance material that breaks the boundaries of architecture and design.

Dekton® is stone

Dekton® is a sophisticated blend of more than 20 minerals extracted from nature.

Dekton® is a totally inorganic material with unbeatable hardness and strength properties that do not deteriorate.

Dekton® is ultra-compact

Dekton® is the only material in its sector that uses a 25,000 tn press in its ultra-compact process.

Dekton®'s exclusive press generates a pressure equivalent to 2.5 times the weight of the Eiffel Tower, resulting in a material with no weak points and almost zero porosity.

Dekton® is sintered

Dekton® perfects in a few hours what nature creates in thousands of years.

Particle Sintering Technology (PST) binds mineral particles together to achieve a homogenised and compacted internal structure.

Dekton® is technique

Dekton® is a high performance, multi-purpose material for the world of architecture and design.

Its strength, variety of formats, sizes and installation options make it perfect for all types of applications and construction solutions. It withstands the most demanding conditions, even in its 4 mm thickness.



Dekton® Features

The beauty of peak performance.
The beauty of imagining with no limits.



Abrasion-resistant

Dekton® withstands abrasion better than granite and porcelain, making it ideal for all interior and exterior applications, including façades and flooring in busy commercial spaces.



Scratch and impact resistant

Dekton®'s great resistance to impact and scratches makes it perfect for everyday use. Its hardness equals quartz, scoring 7/10 on the Mohs scale of mineral hardness.



Water and stain resistant

Dekton®'s variety of thicknesses allow it to be used in applications where resistance to wind or impact are a project requirement.



Fire resistant

Dekton® is classified A1, which certifies it as a non-combustible material capable of withstanding high temperatures without burning.



Resistant to extreme temperatures

Its thermal conductivity, mean bending strength and low coefficient of expansion make it ideal for projects exposed to sudden changes in temperature, frost, wind or heat. In addition, it can be installed with minimal joint spacing.



UV rays resistant

Dekton® is unaffected by ultraviolet rays. Its colour will not fade or degrade over time, maintaining the same appearance as the day it was installed in any interior or exterior application.



Variety of sizes

Dekton® is available in both small formats of 71 x 71 cm and large formats of 320 x 144 cm, perfect for giving visual continuity to large spaces with a minimum number of joints.



Variety of thicknesses

It is available in thicknesses of 30, 20, 12, 8 or 4 mm (Dekton® Slim). A thickness for every application, always ensuring the highest performance.



Variety of colours and textures

Each Dekton® collection offers a myriad of colours in a wide range of finishes, from ultra-gloss to matt or velvet.



Customisation possibilities

Dekton® offers the possibility of customising colours and complex cuts, thus creating unique pieces that result in unforgettable spaces and open up limitless design possibilities.



Easy installation & cost optimisation

Lower cost and lighter weight with the Dekton® Optimma format (260 x 100 cm in 4 mm thickness), specially designed and manufactured for the most common vertical cladding applications.



Creation of continuous spaces

Thanks to its properties, Dekton® can be installed with virtually imperceptible joints, thus ensuring colour uniformity over the entire surface and covering large spaces in a continuous and natural way.

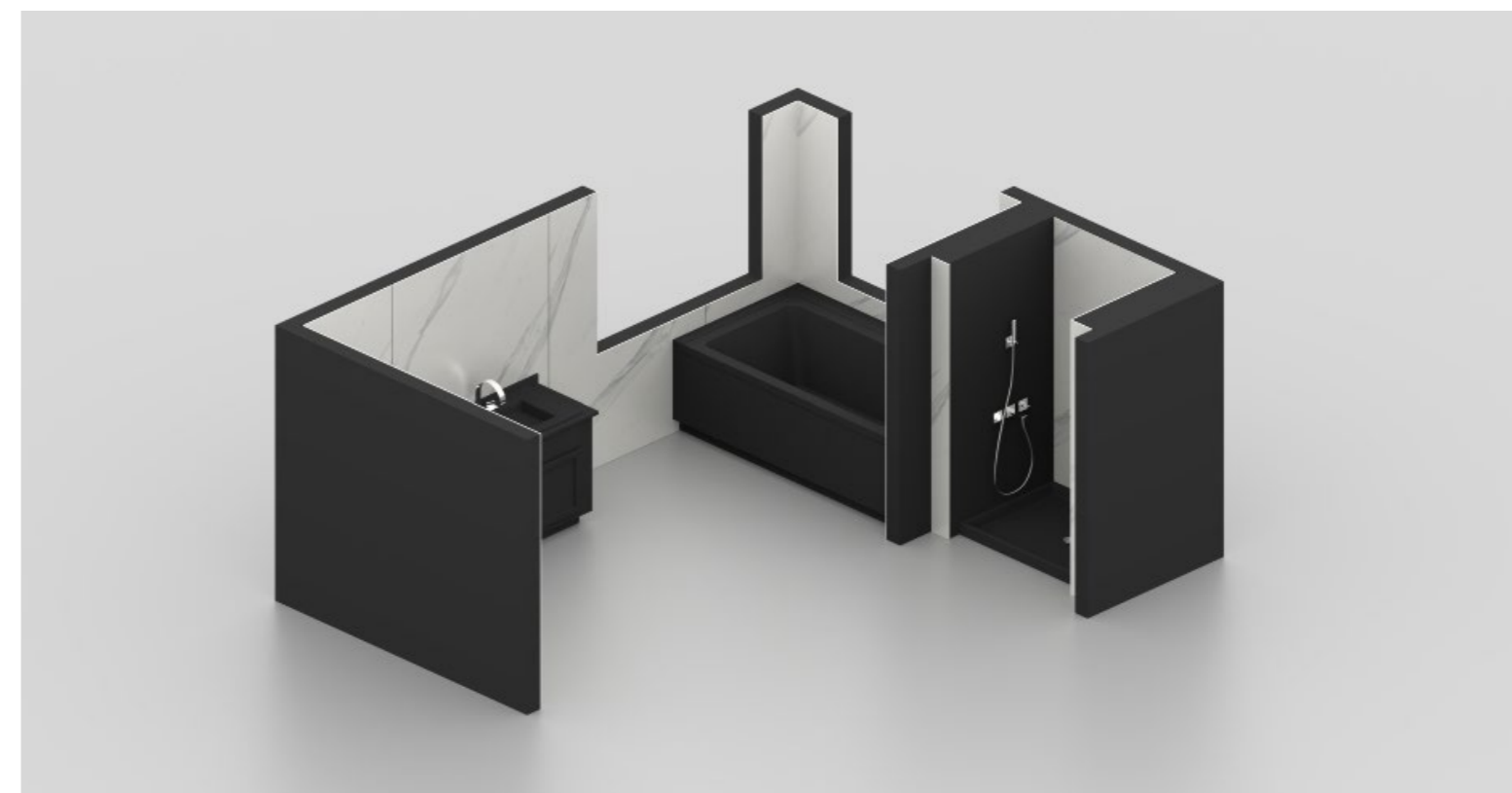

DEKTON® SLIM
Designed by COSENTINO

Dekton® Slim 4 mm

All the properties of Dekton®
in an ultra-thin surface,
unique in its category.

Large format and minimum number of joints

Large format,
4 mm thick slabs offer limitless
design possibilities and are very
easy to install and transport.

Ideal for cladding and flooring,
both indoors and out.

Dekton® formats

Flexible and versatile. For any space.

Whatever the project, indoors or out, and however complex it may be, Dekton® offers a variety of thicknesses and standard formats customised to meet the functional and creative needs of architects and designers.

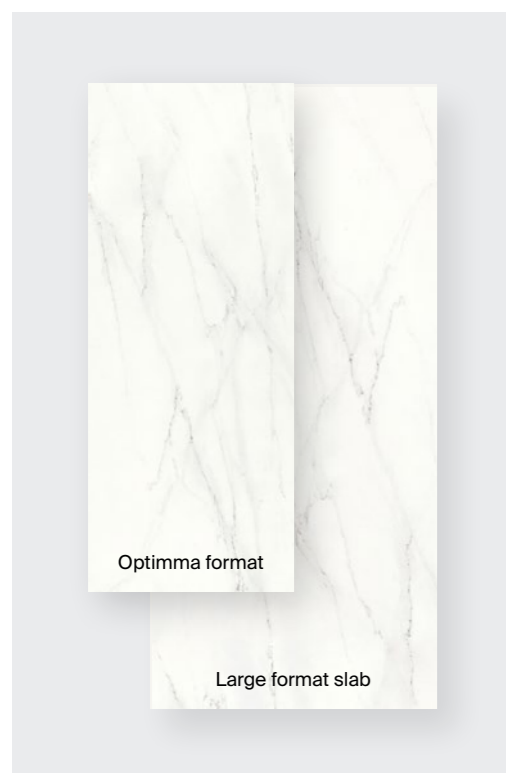

Large format

Optimma format → 260 x 100 cm
Large format slab → 320 x 144 cm

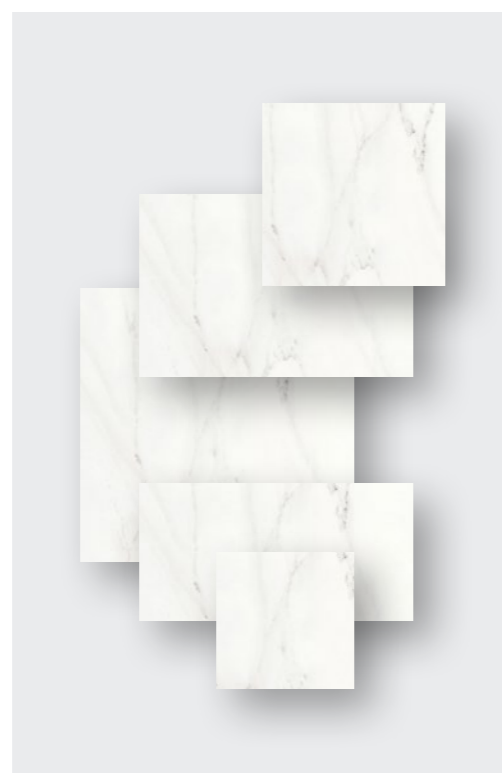

Other format

106 x 71 cm
142 x 106 cm
142 x 142 cm
142 x 71 cm
142 x 79 cm
159 x 142 cm
159 x 71 cm
71 x 71 cm
Custom formats



Thicknesses

4 mm (with mesh, cladding only)
8 mm
12 mm
20 mm
30 mm

Dekton® textures

Different material sensations. A rich variety of shades.

Dekton® comes in different textures so that the only limit is the imagination of the architect or designer: from an ultra glossy finish, to matt or velvety textured finishes.



X-Gloss

A bright, dazzling finish achieved through mechanical polishing, without the need for glazes or other materials.

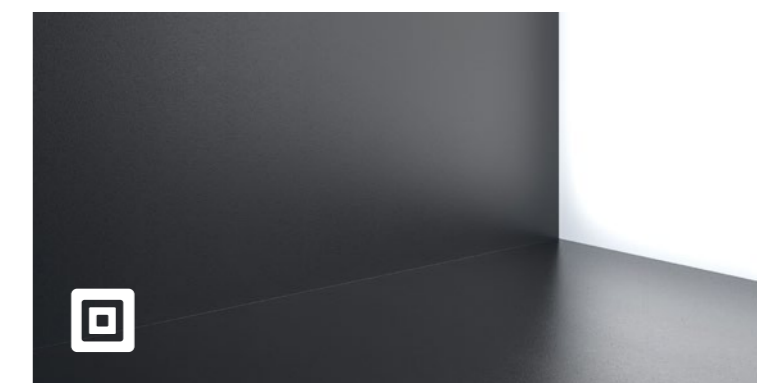

Matt

The matt texture aims for a natural, shine-free look, ideal for a harmonious and timeless finish. Most Dekton® products come in this finish.



Velvet

Velvet is Dekton®'s velvety texture. The materials chosen in Velvet create a feeling of warmth and comfort. This texture is perfect for classic colours, with veins.

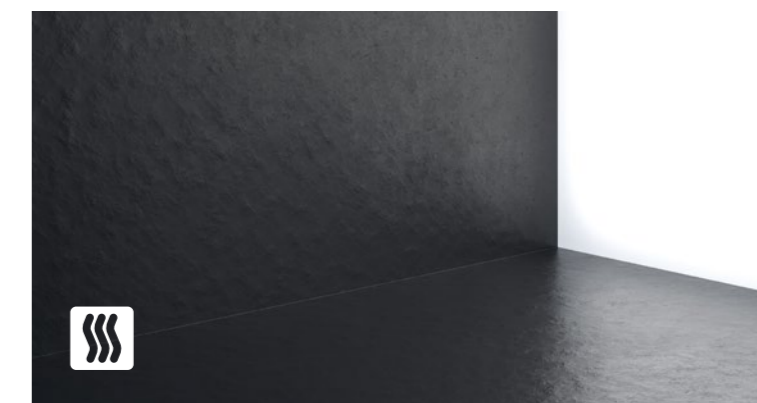

Matt and Textured Velvet

Matt and Textured Velvet textures combine the warmth of velvet with the roughness of a textured, imperfect material. It is perfect for emulating the finish of natural stone.

Silestone®.

The ultimate mineral.

HybriQ surface

Silestone® is a hybrid surface made of minerals and recycled materials designed to bring colour and texture to interior spaces.

Acid and scratch resistant

Silestone® is highly resistant to scratches and impacts, as well as to external agents and acids common in everyday kitchen use.

Impact resistant

The high impact resistance of Silestone® allows for the handling of hard objects (pots, trays, etc.) with total peace of mind.

Stain resistant

Silestone® is a non-porous surface that is highly resistant to stains from coffee, wine, lemon juice, oil, vinegar, make-up and many other everyday products.

Silestone® Advantages

Silestone® is extremely durable in kitchens, bathrooms and other spaces exposed to constant activity and use. In addition, it offers an unlimited range of colours and textures.

Silestone® has many advantages, including low maintenance, high resistance to stains and scratches, and a low fluid absorption rate. This resistance to fluids and its minimal joints make Silestone® the ideal solution for places where liquids are present. Silestone® is hard-wearing and allows prolonged use over time to last a lifetime.

The properties of Silestone® are the result of constant years of innovation that guarantee maximum hygiene and safety.



Silestone® HybriQ+ Technology

HybriQ is a technology developed by Cosentino® consisting of an environmentally friendly manufacturing process and a renewed formula for Silestone® surfaces based on minerals and recycled materials.

More innovation

More design

More sustainable

HybriQ+ uses a minimum of 20% recycled materials, 99% recycled water and 100% renewable energy.

Same performance

Silestone® with HybriQ+ boasts all the quality, durability and warranty features that have made Silestone® the benchmark in the kitchen surface market.

This new generation maintains the high quality that characterises Silestone® surfaces.



 **99%**
Recycled water

 **100%**
Renewable energy

 **0%**
Water discharge

 **at least 20%**
Recycled materials

Silestone® formats

Multiple possibilities for indoor applications.

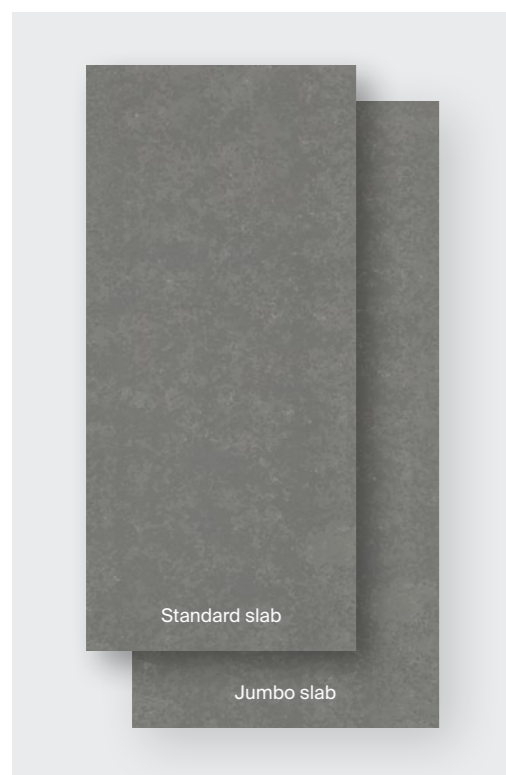

Large format

Jumbo slabs – 327 x 159 cm
Standard slabs – 306 x 140 cm

Jumbo slabs

Cosentino® offers Silestone® slabs in Jumbo format (327 x 159 cm max.) This format allows large surfaces to be created with a minimum number of joints, design versatility and improved hygiene.

This optimises the use of the slab and minimises waste.



Other format

30 x 30 cm
40 x 40 cm
60 x 60 cm
60 x 30 cm
60 x 40 cm
Custom formats



Thicknesses

12 mm
20 mm
30 mm
Custom thicknesses by combining different pieces together

Silestone® Textures.

Surface sensory perception.

In order to adapt to all styles, Silestone® comes in different textures for any of its applications. Polished, Suede or Volcano are three possibilities that let your imagination run wild and provide your worktops, floors or walls with the texture you have always wanted.



Polished

Extremely glossy and smooth texture with an intense and consistent colour.

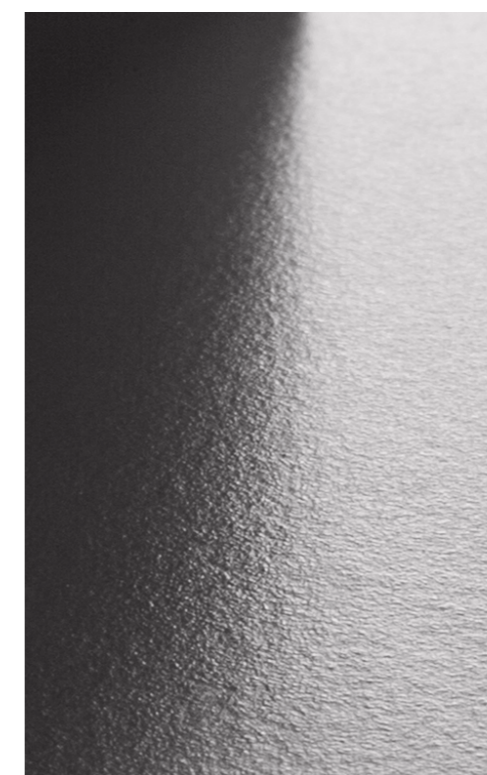

Suede

A matte finish which offers a unique soft and pleasant feel.



Soft sandblasted (Anti-slip)

Surface available exclusively in the shower tray range to guarantee maximum anti-slip safety.

Sensa by Cosentino®

Protected natural stone surface

Sensa by Cosentino® is a premium, maintenance-free natural stone brought to you by Cosentino®, a world leader in the natural stone industry. Sensa by Cosentino® is treated with a revolutionary stain-resistant treatment called SenGuard, and comes with a 15-year warranty against staining.

Applications

Bathroom benchtops.
Stain-proof natural beauty

Enjoy the design, durability and resistance of natural stone without worrying about stains. Sensa by Cosentino® quartzites and granites are treated with a revolutionary stain-resistant treatment that will protect your benchtop and keep it looking as good as new.

Textures

Unique shapes for
one of a kind surfaces

The colours and textures of Sensa by Cosentino® features the subtle yet playful design of nature. Each of the available shades has a texture that produces different effects and sensations: suede, polished or caresse.

Sensa by Cosentino® Treatment

Cosentino® applies an invisible, long lasting treatment to quartzite and granite, which is chemically integrated into the material allowing it to breathe. This technology increases its powerful natural properties and prolongs its life.

The process changes the surface tension of the stone, enabling the material itself to prevent liquids from penetrating it.



Innovative colours and textures to design spaces full of character and originality.

Silestone®, Dekton® and Sensa surfaces come in a wide variety of colours and textures: uniform, veined, etc. From classic iconic stone to new designs in solid colours, innovative patterns and textures that go beyond the visual dimension to offer a unique sensory experience.

Innovation and technology in design. A range of versatile colours and textures to give character and originality to any bathroom.

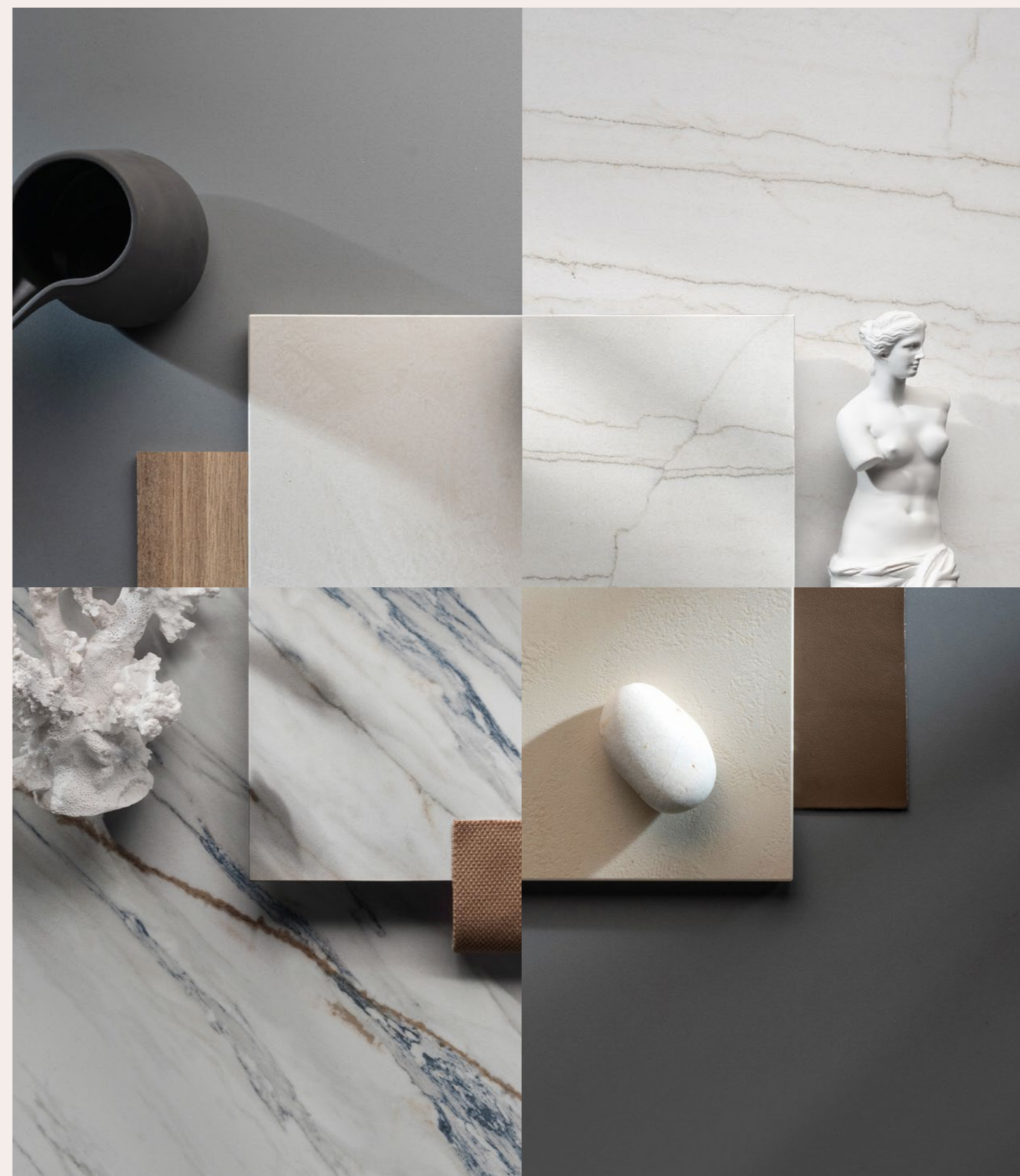

Colours



Dekton Malibu

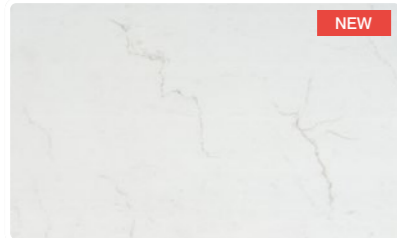

Dekton Laguna



Dekton Salina



Dekton Marina



Silestone Eclectic Pearl

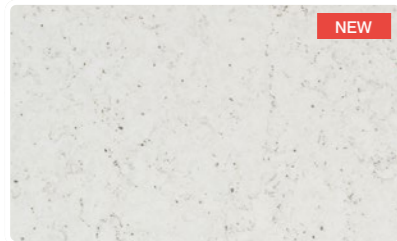

Silestone Lime Delight



Silestone Versailles Ivory

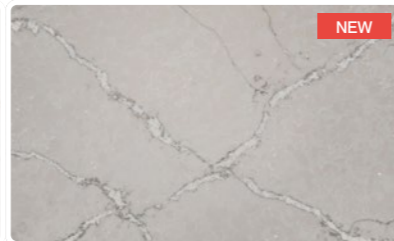

Silestone Victorian Silver

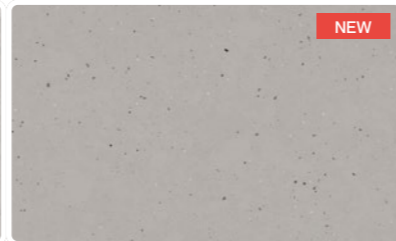

Silestone Concrete Pulse

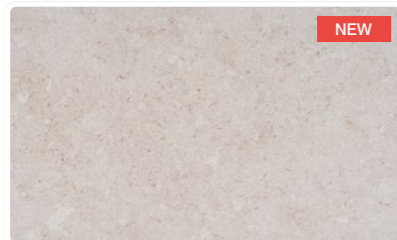

Dekton VK01 Nebbia



Dekton TK05 Sabbia

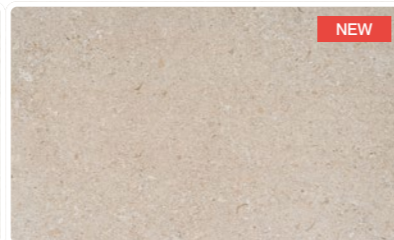

Dekton VK02 Avorio

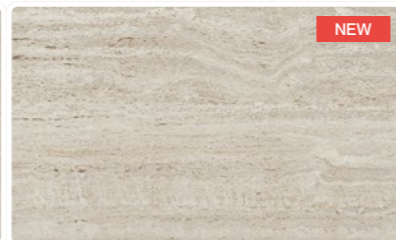

Dekton TK06 Marmorio



Dekton GK07 Ceppo

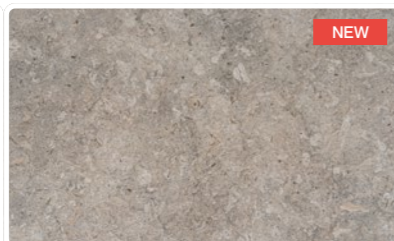

Dekton VK03 Grigio



Silestone Parisien Bleu

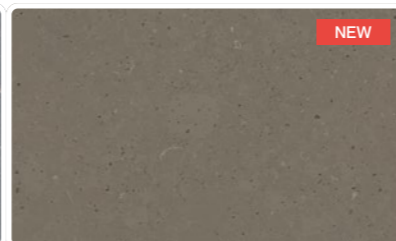

Silestone Brass Relish

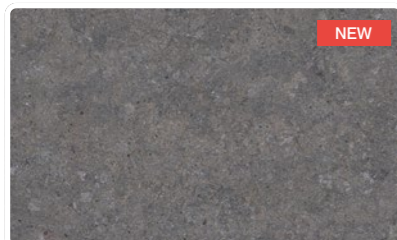

Dekton VK04 Grafite

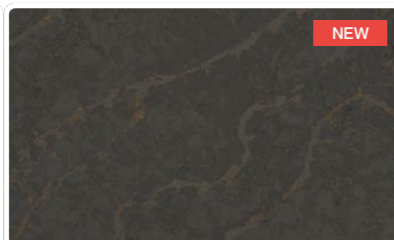

Silestone Bohemian Flame

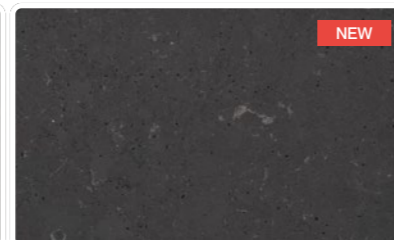

Silestone Cinder Craze

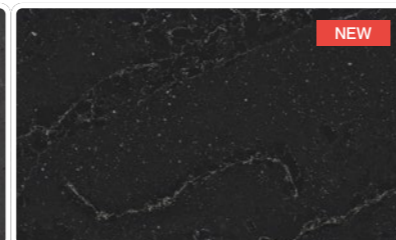

Silestone Romantic Ash



Dekton Uyuni



Silestone Iconic White



Silestone Blanco Zeus



Dekton Zenith

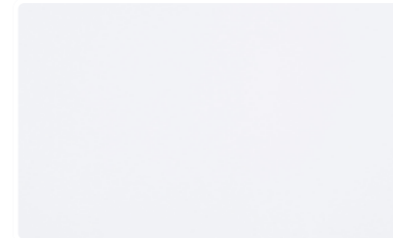

Silestone Miami White

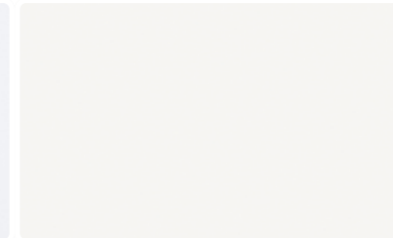

Dekton Halo

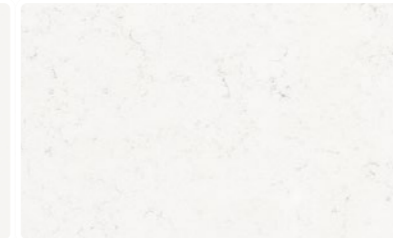

Silestone Miami Vena

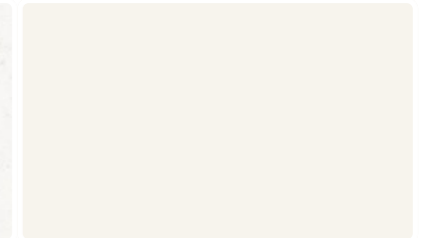

Dekton Mooné

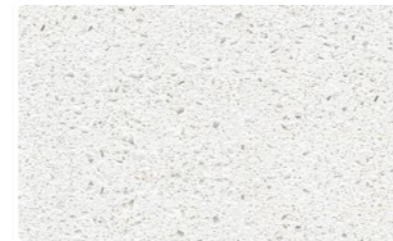

Silestone Blanco Maple 14

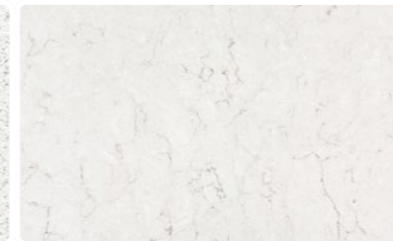

Silestone Snowy Ibiza



Silestone Eternal Statuario



Silestone Calacatta Gold



Silestone Ethereal Glow



Silestone Ethereal Dusk



Silestone Ethereal Haze

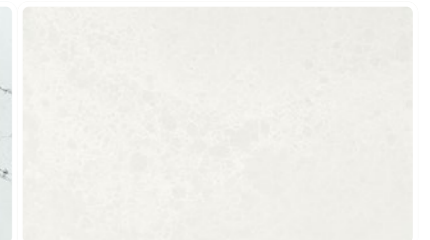

Silestone Nolita

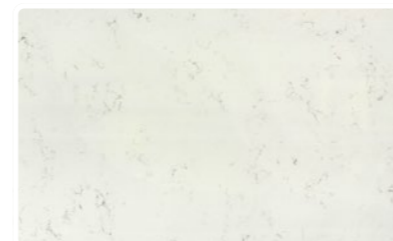

Silestone Ariel

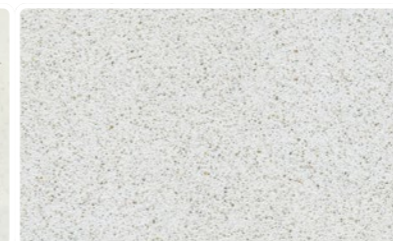

Silestone Blanco Norte 14

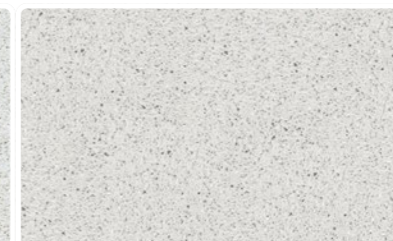

Silestone Blanco Stellar

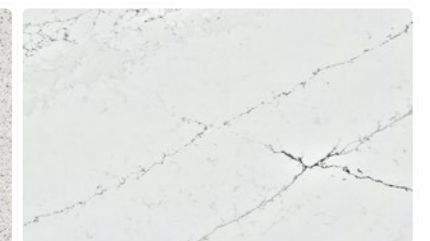

Silestone Ethereal Noctis

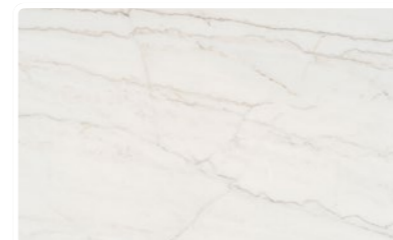

Dekton Limbo



Dekton Rem



Dekton Vigil



Dekton Neural



Silestone Pearl Jasmine * ● Q



Dekton Aura 22 □ ◻



Dekton Opera ◻ ◻ kC



Dekton Entzo 22 □



Dekton Daze ◻ ◻ kC

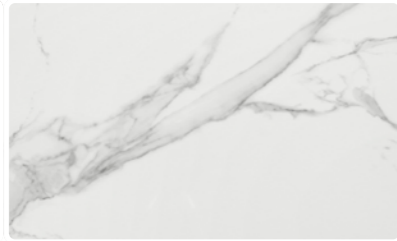

Dekton Natura 22 * ◻ ◻



Dekton Olimpo * ◻ kC



Dekton Lucid * ◻ ◻ kC



Dekton Morpheus ◻ ◻ kC



Dekton Awake * ◻ ◻ kC



Dekton Reverie ◻ ◻ kC



Dekton Trance * ◻ ◻ kC



Dekton Helena 22 * ◻ ◻

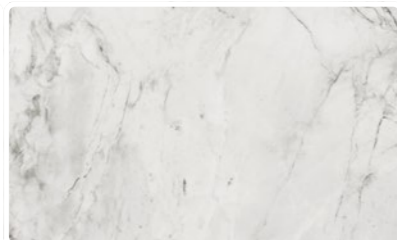

Dekton Bergen * ◻ ◻ kC



Dekton Portum ◻ ◻ kC



Silestone Niebla * ● ◻ Q

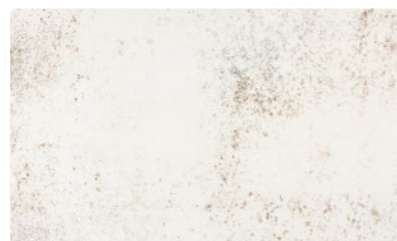

Dekton Nilium 22 □

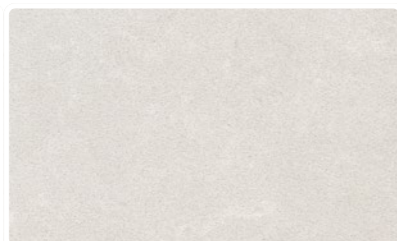

Silestone Yukon * ● ◻ Q

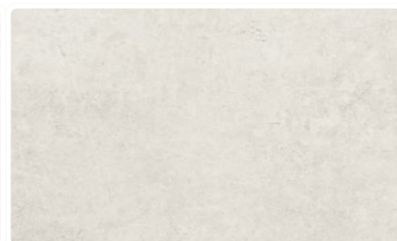

Dekton Lunar 22 ◻ ◻ ◻

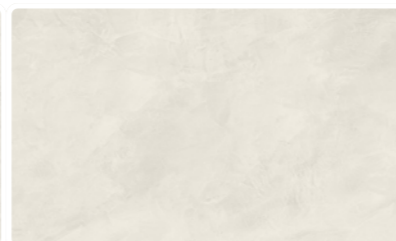

Dekton Albarium 22 ◻ ◻ ◻

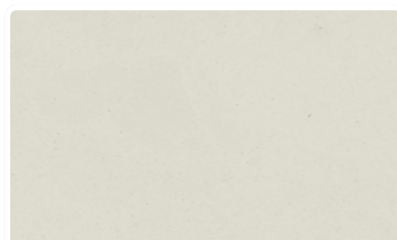

Dekton Aeris ◻ ◻ ◻

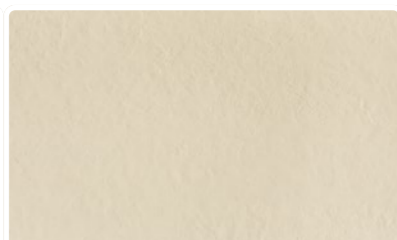

Dekton Edora ◻ ◻ ◻



Dekton Danae ◻ ◻

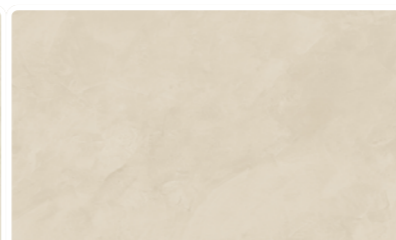

Dekton Nacre ◻ ◻ ◻



Dekton Sasea ◻ ◻ ◻

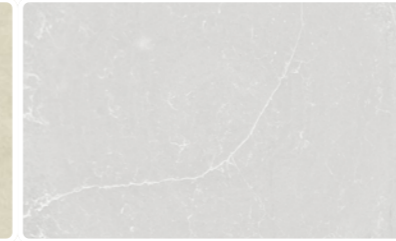

Silestone Desert Silver * ● ◻ Q



Sensa Siberia *

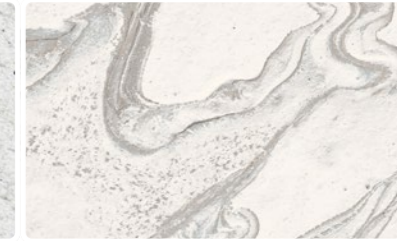

Dekton Liquid Sky 22 ◻ ◻



Sensa Colonial White *

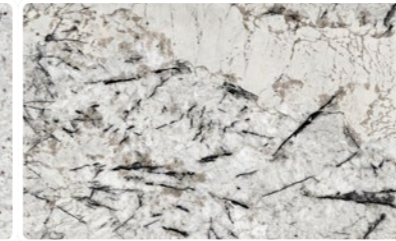

Sensa Ice Blu 19 *



Sensa San Angelo ●



Silestone Faro White ● ◻ Q+

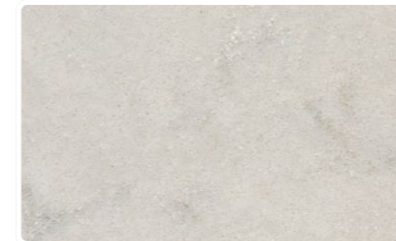

Silestone Lagoon * ● ◻ Q



Sensa White Macaúbas *

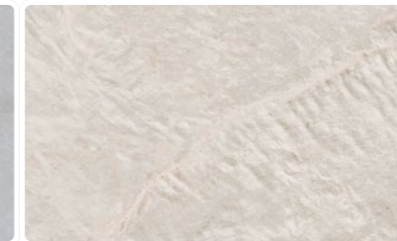

Dekton Liquid Shell 22 ◻ ◻

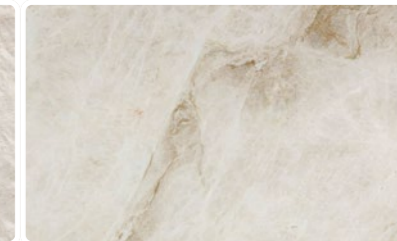

Sensa Taj Mahal * ●

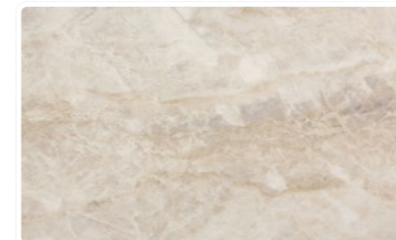

Dekton Arga * ◻ ◻

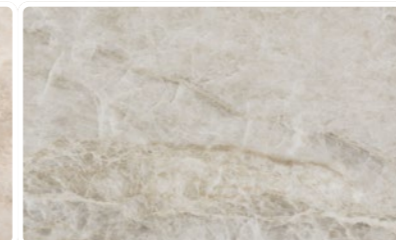

Dekton Taga *

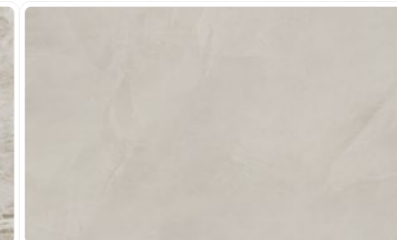

Dekton Argentium ◻ ◻ ◻



Sensa Glacial Blue *

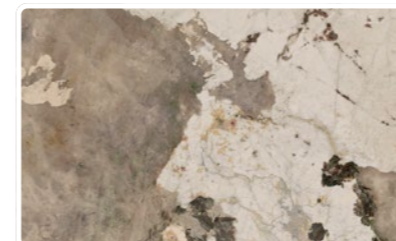

Dekton Khalo *



Sensa Vancouver ●

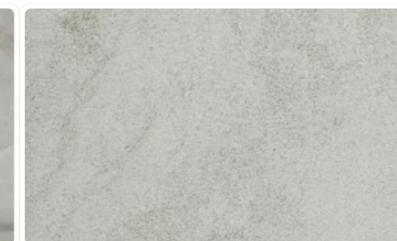

Dekton Kovik ◻ ◻



Silestone Eternal Serena * ● ◻ Q

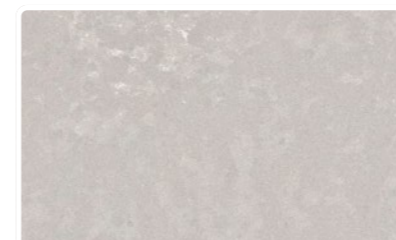

Silestone Poblenu ● ◻ Q+



Dekton Keon ◻ ◻

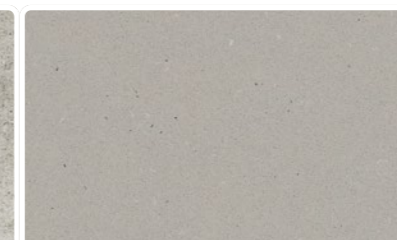

Silestone Camden ● ◻ Q

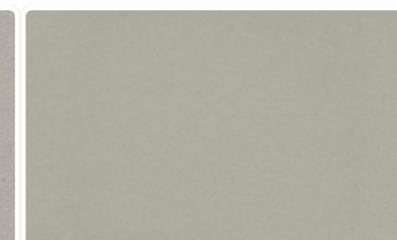

Silestone Cincel Grey ● ◻ Q+

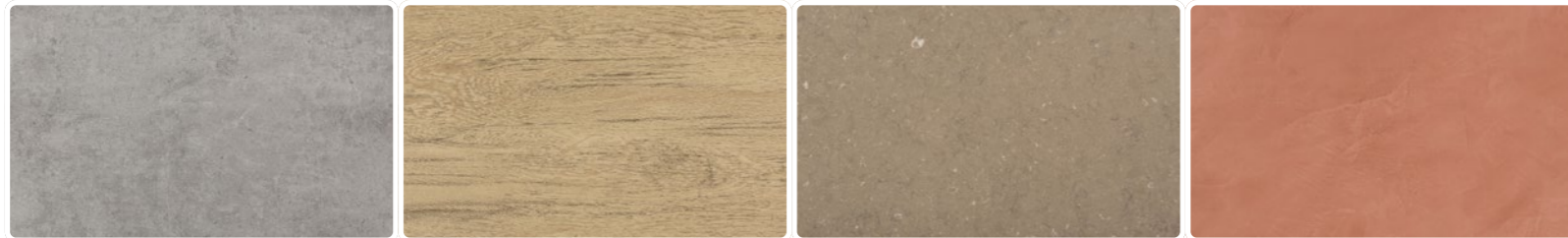

Dekton Kreta Dekton Valterra Silestone Coral Clay Dekton Umber

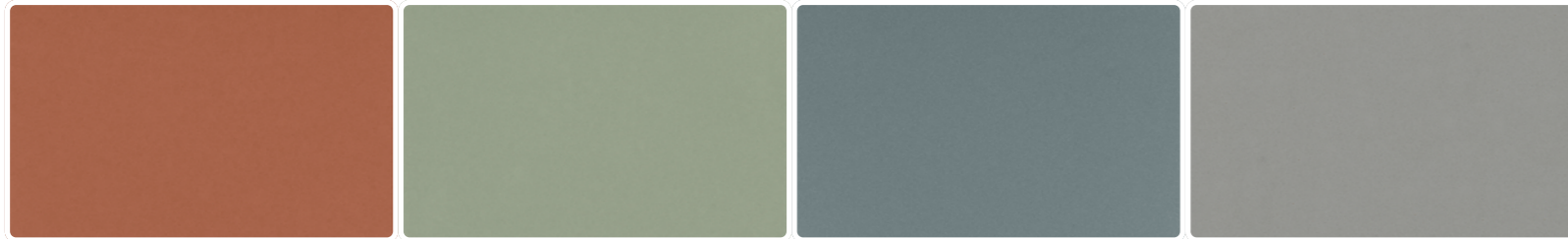

Silestone Arcilla Red Silestone Posidonia Green Silestone Cala Blue Silestone Kensho

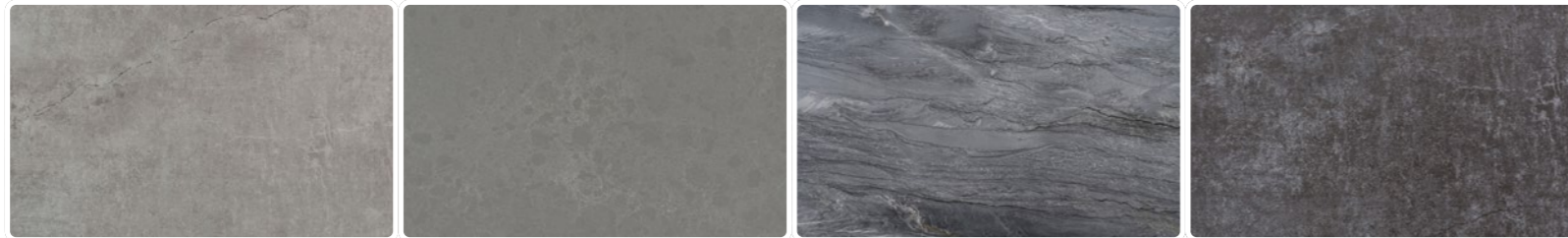

Dekton Soke Silestone Seaport Sensa Platino Dekton Laos

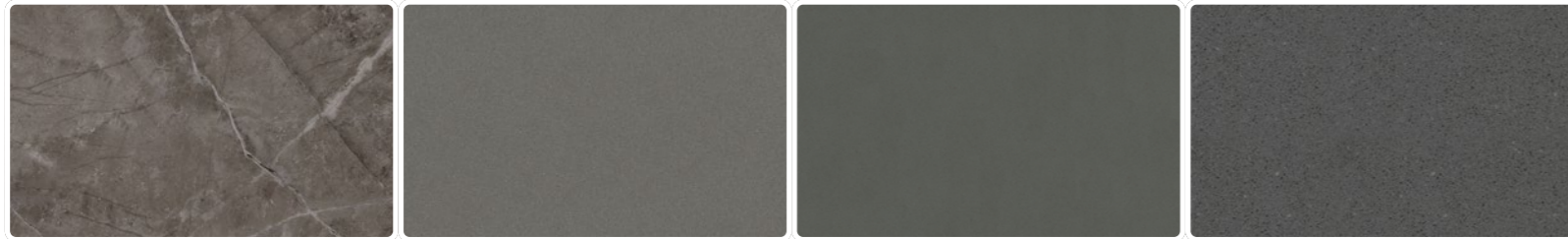

Dekton Kira Silestone Gris Expo Silestone Cemento Spa Silestone Marengo



Silestone Charcoal Soapstone Dekton Micron Dekton Trilium Dekton Keranium

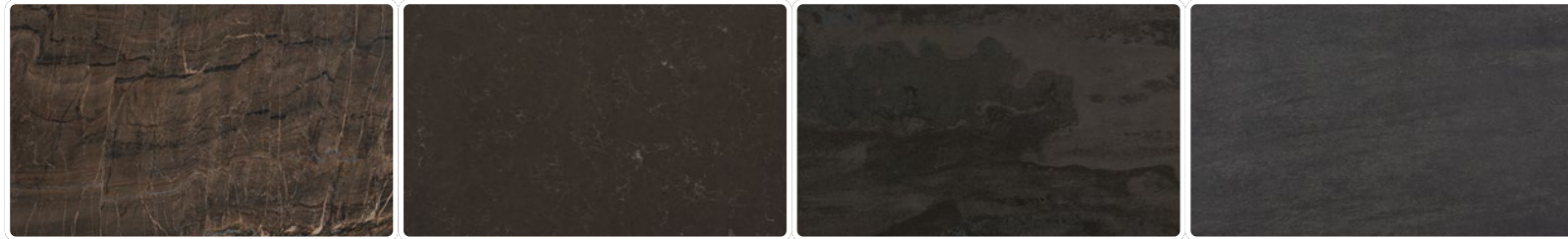

Sensa Nahoa Silestone Calypso Dekton Radium Dekton Bromo

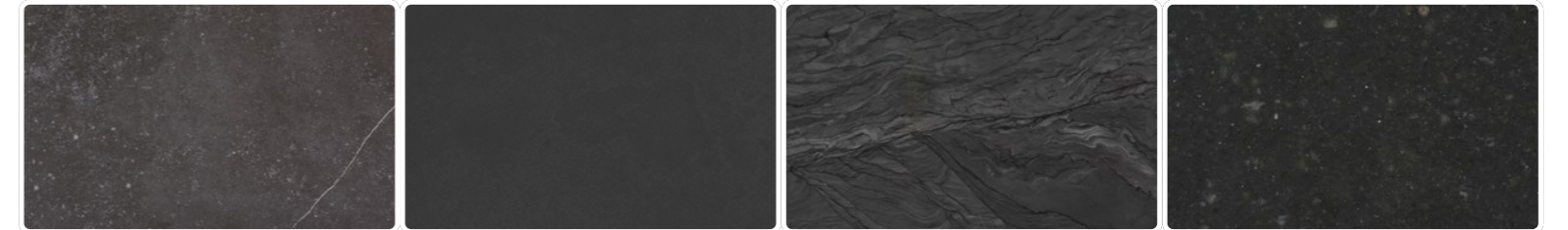

Dekton Fossil Dekton Eter Sensa Nilo Silestone Arden Blue

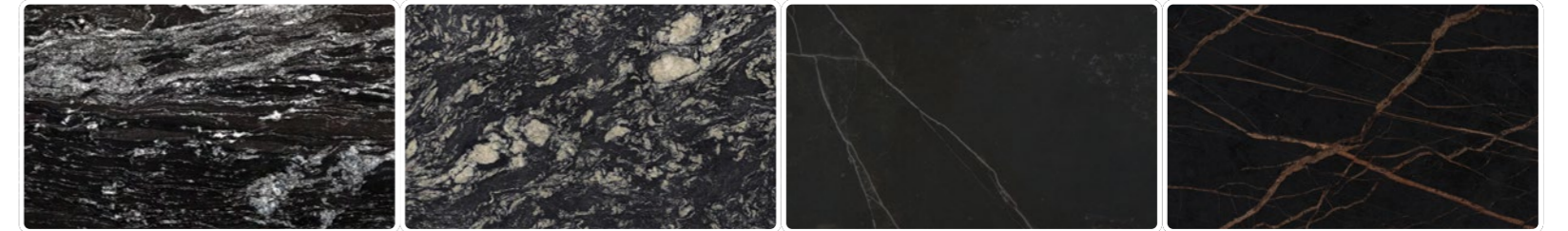

Sensa Black Beauty Sensa Indian Black Dekton Kelya Dekton Laurent

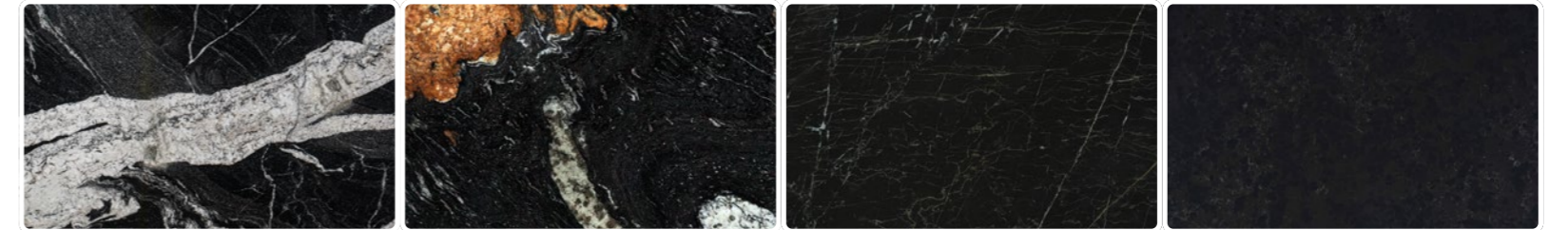

Sensa Maori Sensa Orinoco Dekton Somnia Silestone Corktown

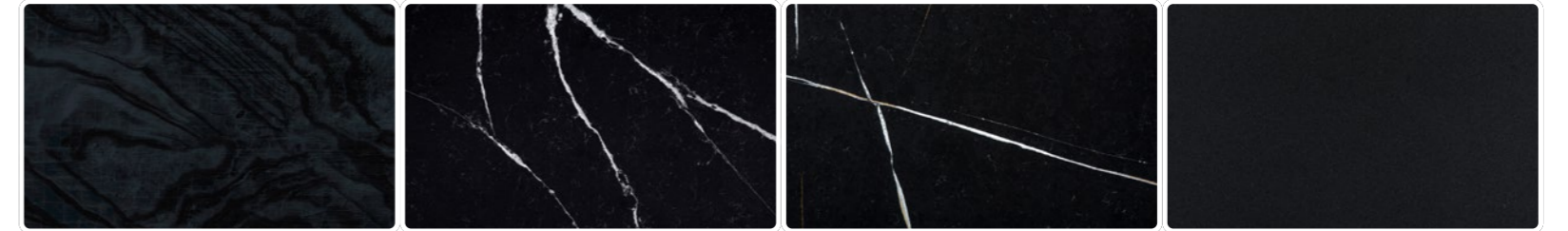

Dekton Liquid Embers Silestone Eternal Marquina Silestone Eternal Noir Sensa Moak Black

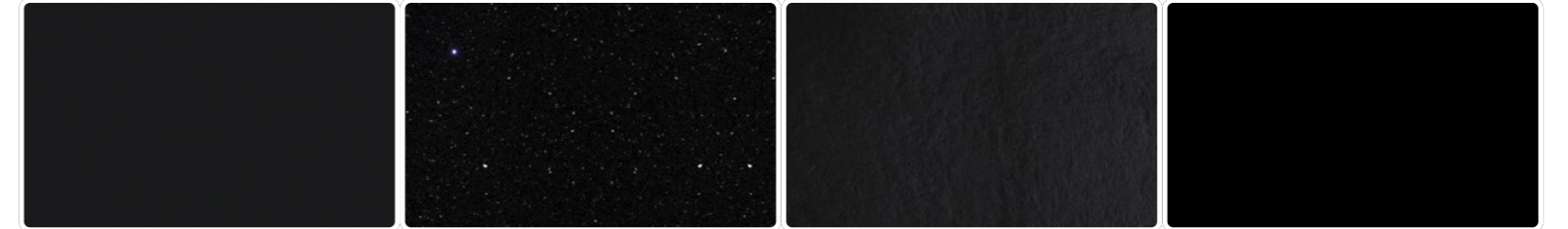

Silestone Negro Tebas Silestone Negro Stellar Dekton Sirius Dekton Domoos

DEKTON® Polished (X-Gloss) Matt (Ultra-Matt) Matt (Velvet) Textured (Ultra-Texture) Dekton® Slim 4 mm
 Quick Cut Technology Dekton® Grip/Grip+. Anti-slip solution for wet surfaces. * Colour only available for shower trays

SILESTONE® Polished Matt (Suede) Integrity Technology HybriQ Technology HybriQ+ Technology

SENSA BY COSENTINO® Polished (Mirage) Matt (Leather) Textured (Caresse)

→ Marie sinks, countertop and cladding Silestone® Posidonia Green



→ Marie Top sinks Silestone® Blanco Zeus / Countertop, flooring and cladding Silestone® Cala Blue



Flooring & Cladding

Visual continuity throughout the space

The same surface is used to clad floors, walls and furniture. Thanks to its large format and almost zero thermal expansion coefficient, it can be installed with fewer, practically imperceptible joints.



Design and patterns.

Three groups of patterns that make the design process easier.

We have classified our Dekton® colour range into three different clusters of patterns to facilitate the design process. All our portfolio is labelled as Infinite Pattern, Singular Pattern or Smooth Pattern, depending on the desired effect for large surfaces and the placement of slabs adjacent to one another, taking into account the orientation of the design, shades and variations.

However, this classification is merely indicative, and we recommend that you contact our Product Department to obtain an individual assessment that guarantees how you can materialise your project the way you imagine it.



Singular Pattern

Designs with colour ranges of greater complexity and a very strong orientation, which result in patterns with a lot of character and variation in smaller cuts or continuous layouts.



Smooth Pattern

Designs with an orientation in the graphic structure that has to be taken into account when cutting and placing the slabs. It is a very versatile type of pattern that requires consideration of orientation in its installation.



Infinite Pattern

Uniform colours or designs with a consistent or almost consistent composition and structure that, when used for cladding such as floors, walls or façades, allow for random placement of slabs, providing a beautifully consistent look.

Optimma format

A Dekton® format optimised for maximum efficiency in the most common applications.

Our Dekton® slabs have been optimised for the most common applications to create a new format with improved cost, design, installation and handling.

260 x 100 cm in 4 mm thickness.

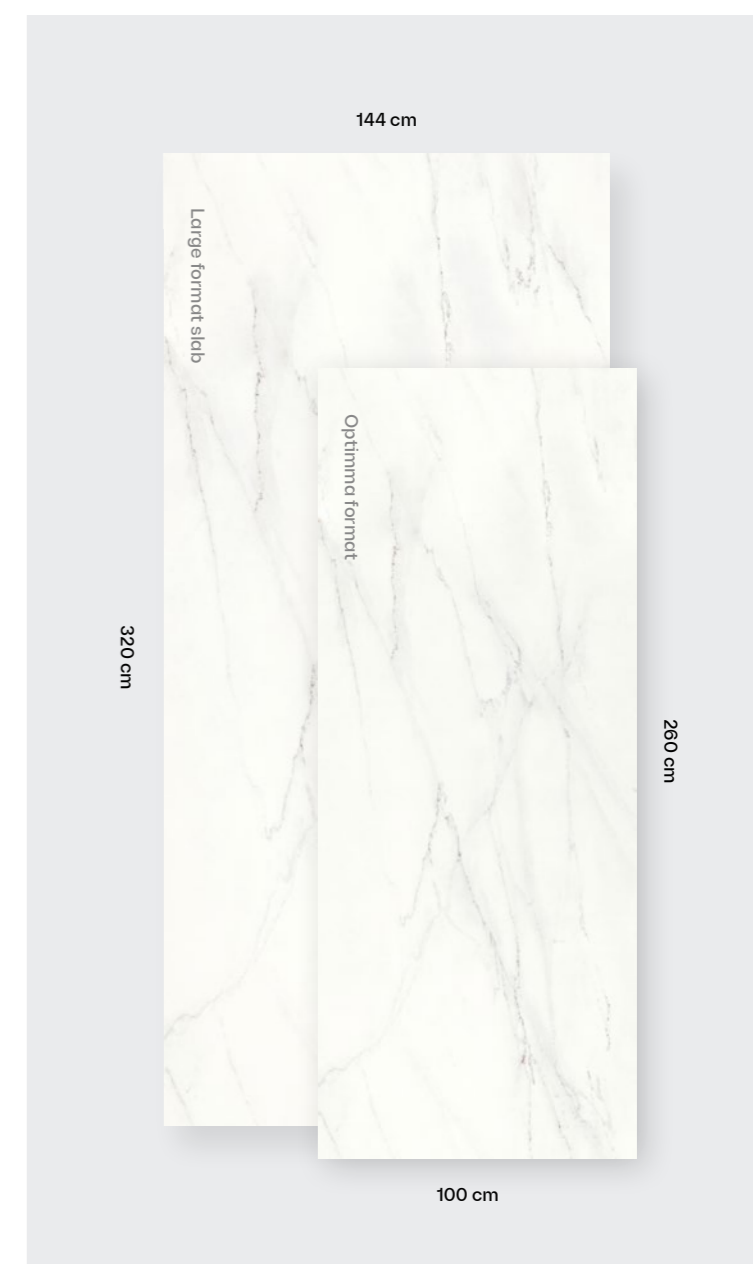

Rotating Pattern

All colours have a rotating pattern, except Rem and Kelya, these have a static pattern.

With rotating pattern the graph is printed with a slight vertical displacement upwards (scroll up) in each one of its iterations (in each slab).

In the static pattern the graph is always printed in the same position, but there is the option that, when position the slabs next to each other horizontally, the one immediately after it rotates 180° with respect to the above, as shown in the following illustration, in order to play with the movement in the design.



Dekton® Book Match

Book Match

Based on some of our designs, we have created unique, symmetrical and interchangeable references that allow compositions and designs to be made where the veins have continuity between different pieces.

Each piece has a unique combination of numbers and letters to select the patterns that best suit your needs according to colour and available thicknesses.

Material on request, check availability.

Dekton® Slim Aura 15
Available in 4, 8, 12 and 20 mm thicknesses

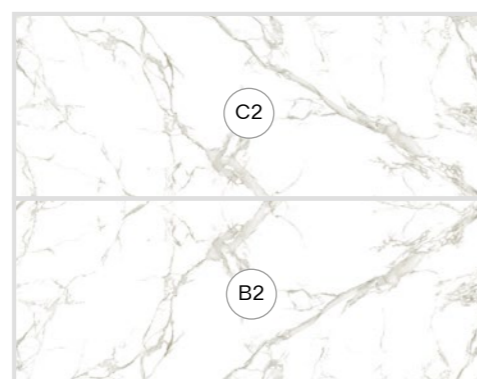

Dekton® Natura 22
Available in 4, 8, 12 and 20 mm thicknesses



Dekton® Awake
Available in 4, 8 and 12 mm thicknesses



Dekton® Lucid y Morpheus
Available in 8, 12 mm and Optimma format

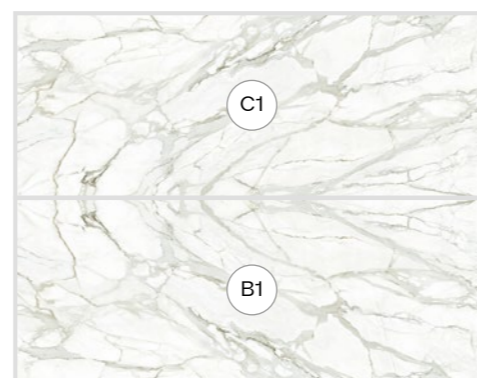

Dekton® Lineal Match y Book Match

Lineal Match

We present a new concept that includes references of the same colour to create a fluid and continuous atmosphere. Focused on large-area flooring and vertical cladding applications.

Dekton® Somnia
Available in 4, 8, 12 mm and Optimma format

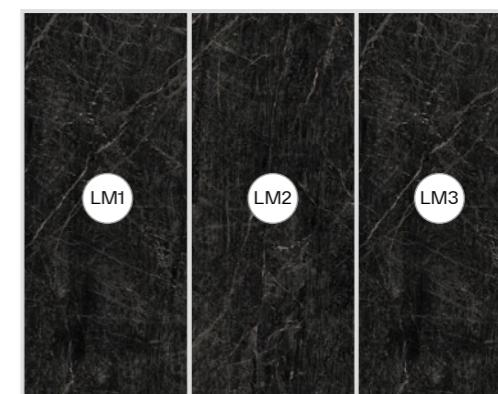

Design Match

A new design conceived to position the slabs vertically. The slab is rotated 180° in each of its iterations, thus creating a continuous and harmonious design.

Dekton® Trance
Available in 4, 8 and 12 mm thicknesses

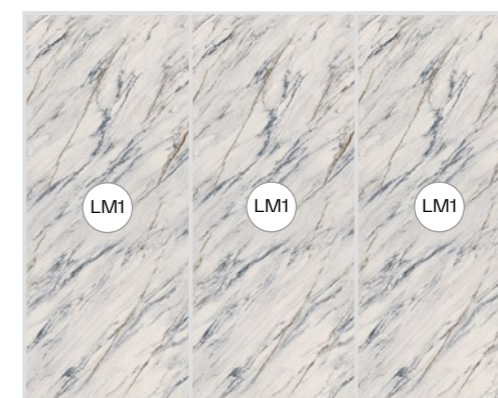



Dekton® Grip & Grip+

Improved grip for any anti-slip application such as bathrooms, swimming pools or outdoor floors.

Each space has different technical needs. We launch to the market a new portfolio for antislip flooring in two finishes Grip and Grip+

Grip, the anti-slip finish that is easy to clean and ideal for light colours.

Grip+, the maximum grip for the most demanding applications and maximum ease of cleaning.

Two highly durable and resistant anti-slip treatments, applied in a controlled manner during the manufacturing process of Dekton®, without the need for chemical or mechanical measures.

Colours with the anti-slip finish may have slight colour differences compared to the standard matt finish, which are more evident in colours such as Sasea or Danae.

Dekton® Grip colours

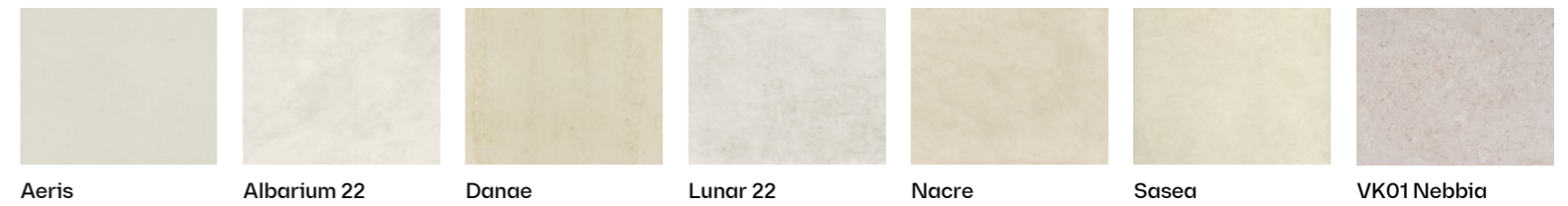

Dekton® Grip+ colours

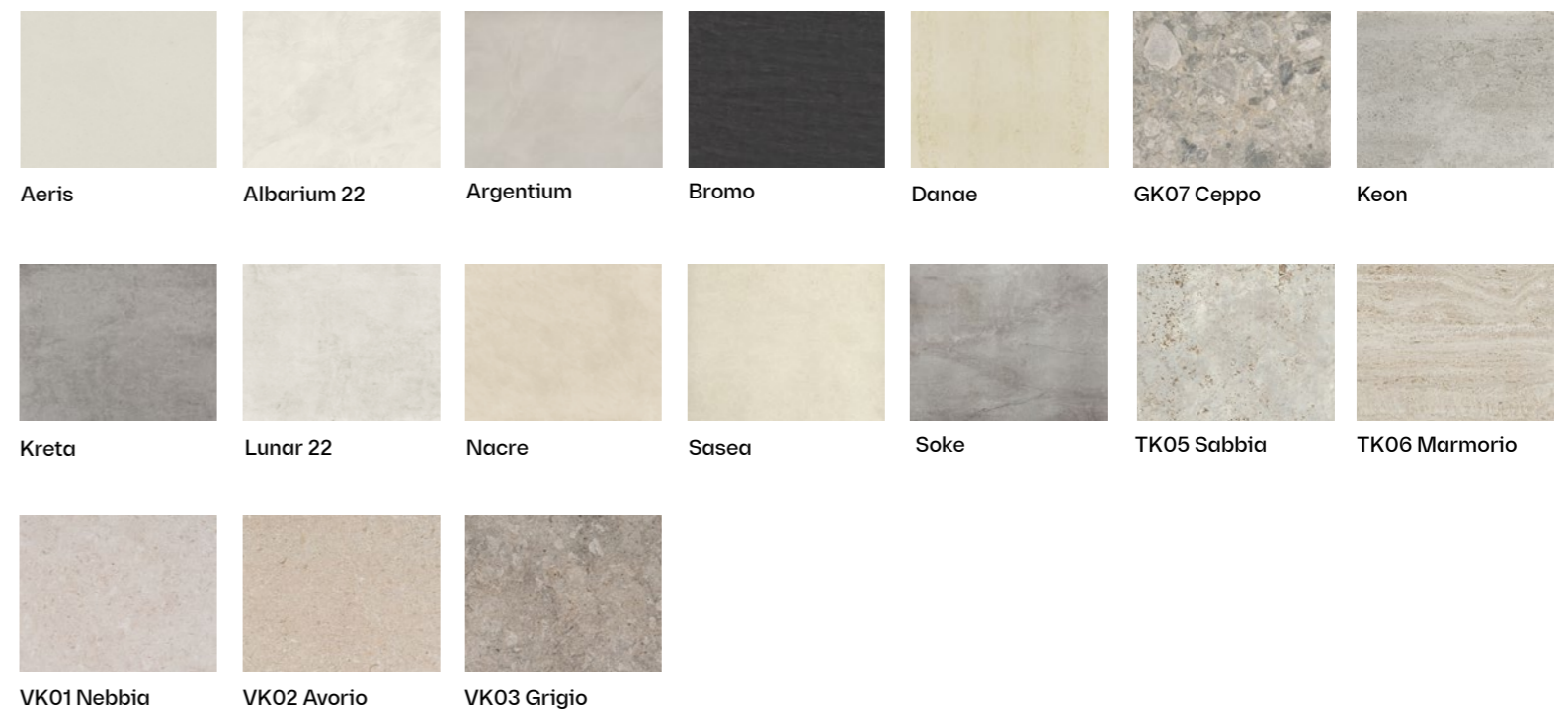

Wash basins & Shower trays

Durability and beauty in timeless features that can fit any space or become an iconic part of the bathroom.

Wash basins, benchtops and shower trays designed with the most cutting edge materials developed by Cosentino®. Maximum durability guaranteed in the main features of bathrooms with an upmarket and timeless design that suits any space, bringing unique bathrooms to life.

Bathroom features that give a personal touch with simplicity, elegance and sophistication to any decorative style.



Wash basins and benchtops

Versatile and
durable designs.

Benchtops and wash basins to suit any space with a wide variety of designs in which geometric balance and sobriety are key. The durability of a timeless aesthetic and the hardness and resistance offered by Cosentino®'s latest generation materials: Silestone® and Dekton®.



5
YEAR
COSENTINO
WARRANTY

Wash basins and benchtops

Full product range

Designer wash basins and benchtops suitable for any space.



Evita
Silestone® Integrity P. 196



Simplicity
Silestone® · Dekton® P. 206



Reflection
Silestone® · Dekton® P. 208



Marie
Silestone® Integrity P. 198



Elegance
Silestone® P. 200



Silence
Silestone® · Dekton® P. 210



HLine Flex
Silestone® · Dekton® P. 212



Armony
Silestone® P. 202

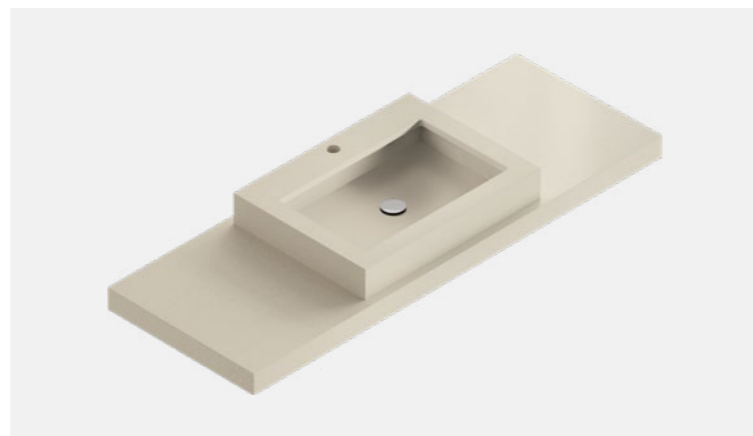

Symmetry
Silestone® P. 204



HLine Urban
Silestone® · Dekton® P. 214



HLine Bath Top
Silestone® · Dekton® P. 216

Evita

Integrity



Three sizes of Integrity wash basins with a round and functional design, which combine technology and integration, offering comfort for the most demanding solutions.



Evita S



Evita L



Evita Q

Characteristics

1. Moulded basin featuring Integrity® technology, without joints, with reduced height and rounded wall corners.
2. Optional overflow.
3. Additional basins can be supplied and fitted.
4. Custom options for benchtop as: towel rails, cut outs, side legs (non structural), skirt heights, etc.
5. Click-clack valve included.
6. Support bars included (for benchtops with skirt).

Tap

With or without drill holes for taps

Overflow

With or without overflow

Integrated basin

Standard S: 50 x 30 x 10 cm
Standard L: 65 x 30 x 10 cm
Standard Q: 51 x 41 x 10 cm

Edging

12 mm straight edge
Skirt: 125 mm

Benchtop

Length from 60 to 320* cm
Width from 40 to 60 cm

* Jumbo slab only. For the maximum length, continuity of veins in the side skirts is not possible.

Available colours

Available in a selected range of Silestone® 12 mm colours polished. Please scan the below QR code to check the latest portfolio of Silestone® Integrity colours



Marie

Integrity



The Integrity wash basin is available in two different formats, on top of or integrated into the benchtop, and two different sizes. Their soft corners and wide variety of finishes are perfect for all bathroom styles.



Marie S



Marie L



Marie TOP S



Marie TOP L

Characteristics

1. Moulded basin featuring Integrity technology, without joints, with reduced height and rounded wall corners.
2. TOP Benchtop wash basins models in exclusive matt finish.
3. Additional basins can be supplied and fitted.
4. Custom options for benchtop as: towel rails, cut outs, side legs (non structural), skirt heights, etc.
5. Click-clack valve included.
6. Support bars included (for benchtops with skirt).

Tap

With or without drill holes for taps

Integrated basin

Standard S: 34 x 37 x 7 cm
Standard L: 51 x 37 x 7 cm

TOP basin

Standard S: 34 x 37 x 10 cm
Standard L: 51 x 37 x 10 cm

Edging

20 mm straight edge
Skirt: 125 mm (integrated) / 10 mm (TOP)

Benchtop

Length from 47 to 320* cm
Width from 44 to 60 cm

* Jumbo slab only. For the maximum length, continuity of veins in the side skirts is not possible.

Available colours

Available in a selected range of Silestone® 20 mm colours Polished or Suede (TOP version in Matt). Please scan the below QR code to check the latest portfolio of Silestone® Integrity colours.



Elegance



Elegance is our well known wash basin made of CTS pieces. Customise your wash basin to get that elegant uniform design you are looking for.



Characteristics

1. Traditional rectangular basin featuring a functional design.
2. Optional overflow.
3. Additional basins can be supplied and fitted.
4. Custom options for benchtop as: towel rails, cut outs, side legs (non structural), skirt heights, etc.
5. Click-clack valve included.
6. Support bars included (for benchtops with skirt).

Tap

With or without drill holes for taps

Overflow

With or without overflow

Integrated basin

Standard: 49 x 30 x 10 cm
Other sizes available for +20 pcs

Edging

20 mm straight edge
Skirt: 125 mm

Benchtop

Length from 59 to 320* cm
Width from 40 to 60 cm

* Jumbo slab only. For the maximum length, continuity of veins in the side skirts is not possible.

Available colours

Available in all Silestone® 20 mm colours, polished or suede. Please scan the below QR code to check the latest portfolio of Silestone® colours



Armony



The evolution of tradition turns this wash basin into the ideal touch for a distinctive bathroom, providing the harmony that the room needs.

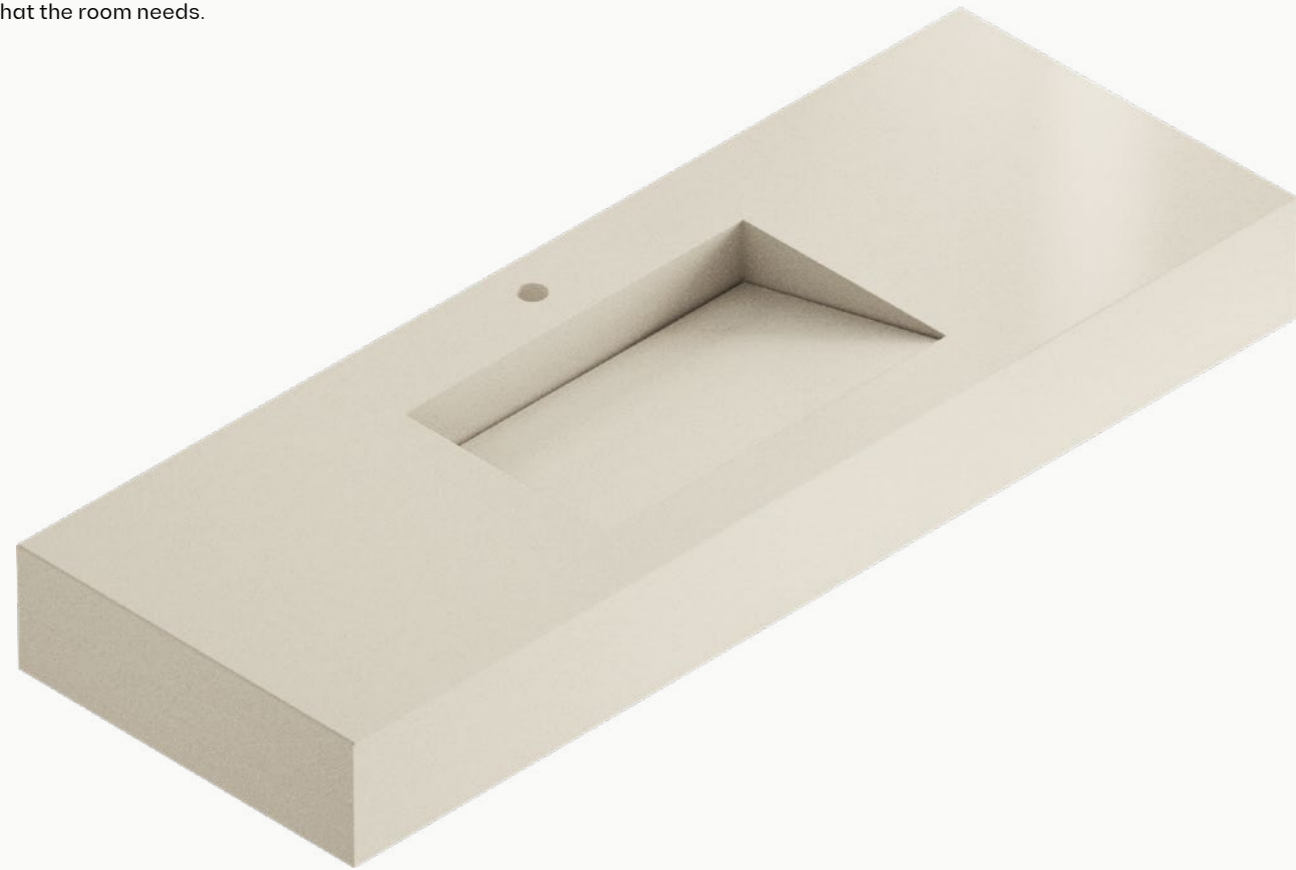

Characteristics

1. Removable ramp for easy cleaning.
2. Additional basins can be supplied and fitted.
3. Custom options for benchtop as: towel rails, cut outs, side legs (non structural), skirt heights, etc.
4. Suction cup to lift the ramp included.
5. Grid sink plug valve included (cannot be closed).
6. Support bars included (for benchtops with skirt).

Tap

With or without drill holes for taps

Integrated basin

Standard: 49 x 30 x 10 cm
Other sizes available for +20 pcs

Edging

20 mm straight edge
Skirt: 160 mm

Benchtop

Length from 59 to 320* cm
Width from 40 to 60 cm

* Jumbo slab only. For the maximum length, continuity of veins in the side skirts is not possible.

Available colours

Available in all Silestone® 20 mm colours, polished or suede. Please scan the below QR code to check the latest portfolio of Silestone® colours



Symmetry



Innovative wash basin design with straight lines and reduced height, available in three different sizes, to provide the ideal solution for the most minimalist spaces.

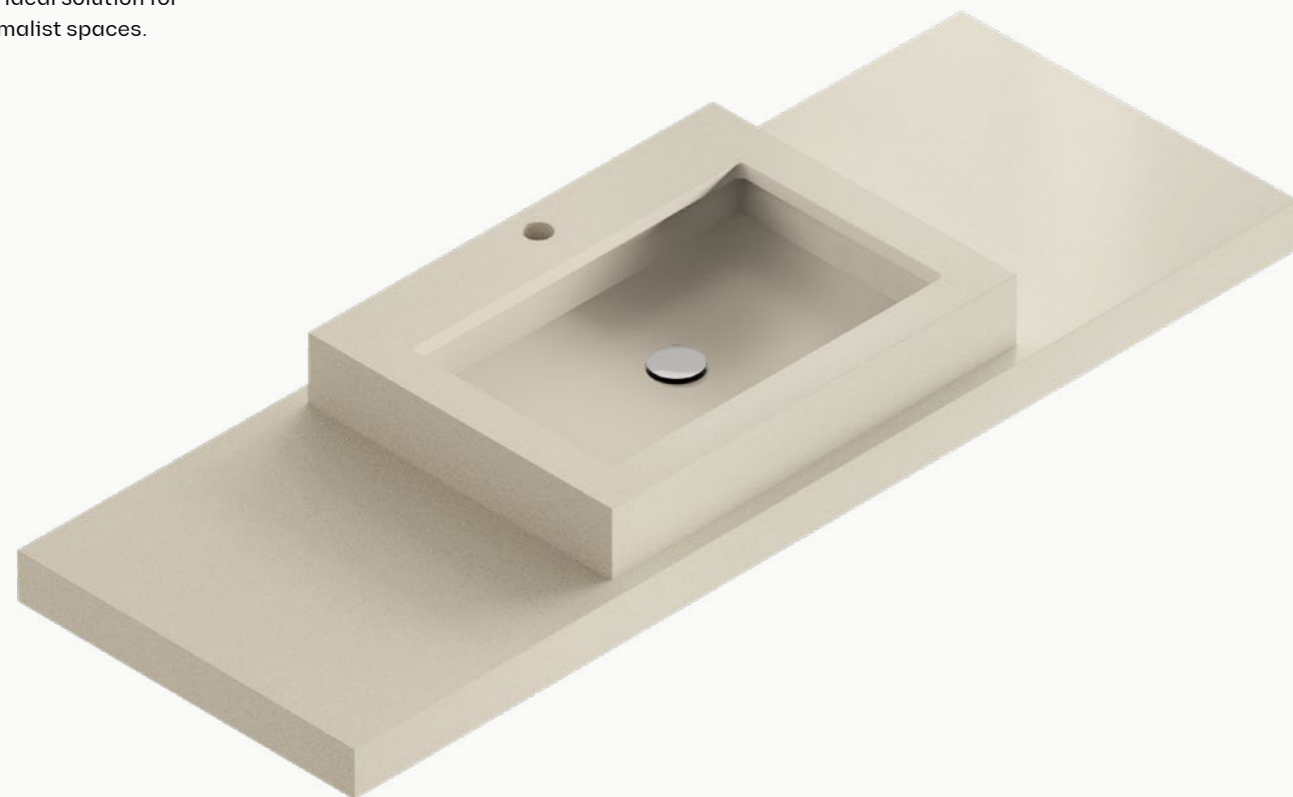

Characteristics

1. Benchtop wash basin suitable for benchtops made of any material.
2. Three sizes of basins to suit every need and every bathroom space.
3. Custom options for benchtop as: towel rails, cut outs, side legs (non structural), skirt heights, etc.
4. Click-clack valve included.
5. Support bars included (for benchtops with skirt).

Tap

With or without drill holes for taps

Under benchtop basin

Standard S: 33 x 23 x 7 cm
(ext. 45 x 38 x 10 cm)

Standard M: 38 x 25 x 7 cm
(ext. 50 x 40 x 10 cm)

Standard L: 58 x 30 x 7 cm
(ext. 70 x 45 x 10 cm)

Other sizes available for +20 pcs

Edging

20 mm straight edge / Skirt: 100 mm

Benchtop

Length from 55 to 320* cm
Width from 43 to 60 cm

* Jumbo slab only. For the maximum length, continuity of veins in the side skirts is not possible.

Available colours

Available in all Silestone® 20 mm colours, polished or suede. Please scan the below QR code to check the latest portfolio of Silestone® colours



Simplicity



A wash basin with a minimalist but practical design. Its modern and elegant lines make it a simple but smart choice for your bathroom.



Characteristics

1. Removable cover for easy cleaning.
2. Fixed ramp with splash-proof slope.
3. Additional basins can be supplied and fitted.
4. Custom options for benchtop as: towel rails, cut outs, side legs (non structural), skirt heights, etc.
5. Suction cup to lift the cover included.
6. Grid sink plug valve included (cannot be closed).
7. Support bars included (for benchtops with skirt).

Tap

With or without drill holes for taps

Under benchtop basin

Standard: 49 x 30 x 10 cm
Other sizes available for +20 pcs

Edging

20 mm straight edge for Silestone®
12 mm straight edge for Dekton®
Skirt: 160 mm

Benchtop

Length from 59 to 320* cm
Width from 44 to 60 cm

* Jumbo slab only for Silestone®. For the maximum length, continuity of veins in the side skirts is not possible.

Available colours

Available in all Silestone® 20 mm colours, polished or suede and Dekton® 12 mm colours. Please scan the below QR code to check the latest portfolio of Silestone® and Dekton® colours



Reflection



Innovative and versatile wash basin, with double drainage. Its innovative design, featuring straight lines, and its range of sizes provide the bespoke solution to adapt your style in the bathroom.

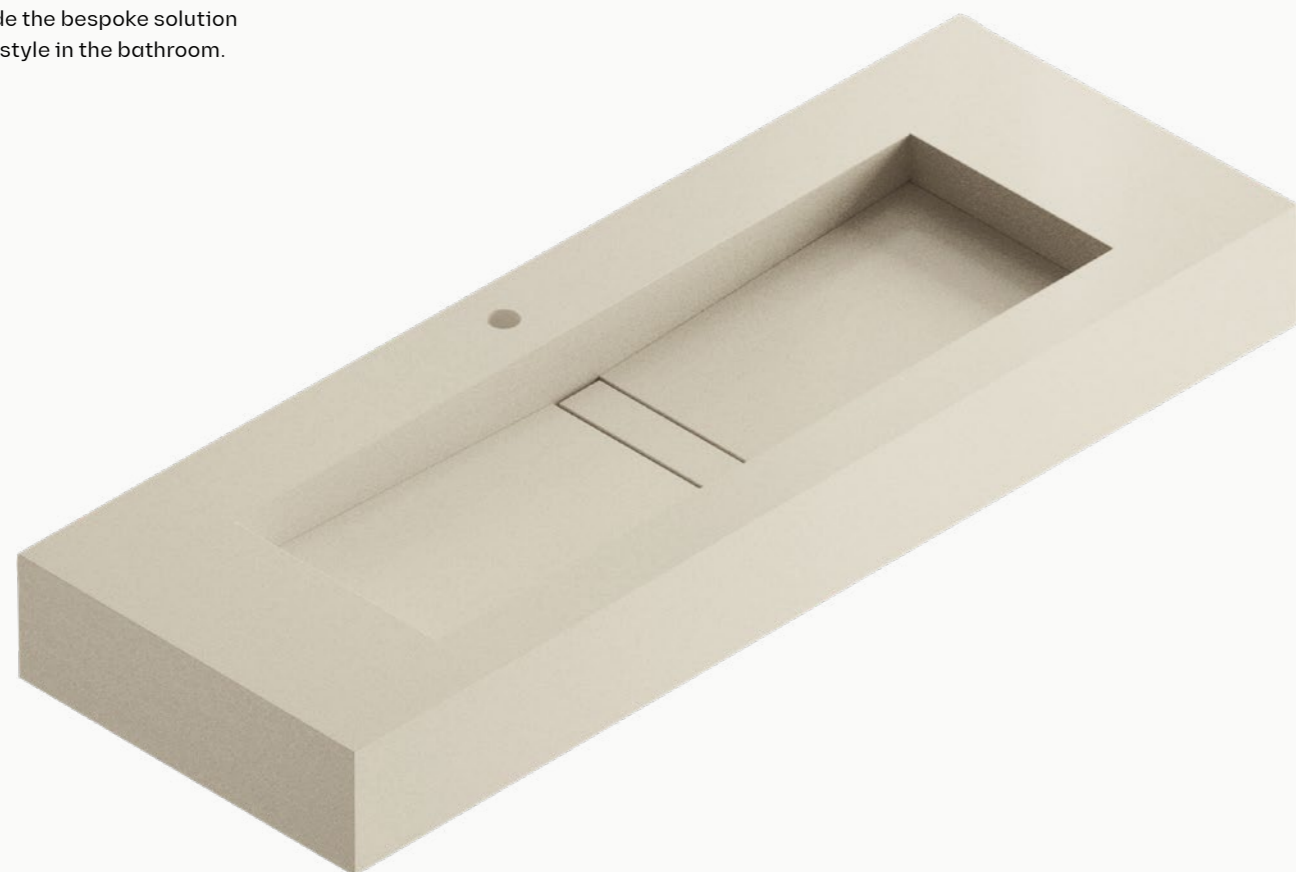

Characteristics

1. Removable cover for easy cleaning.
2. Double drainage slope, perfect for two taps.
3. Additional basins can be supplied and fitted.
4. Custom options for benchtop as: towel rails, cut outs, side legs (non structural), skirt heights, etc.
5. Suction cup to lift the cover included.
6. Grid sink plug valve included (cannot be closed).
7. Support bars included (for benchtops with skirt).

Tap

With or without drill holes for taps

Integrated basin

Standard S: 49 x 30 x 8 cm
Standard M: 90 x 30 x 8 cm
Standard L: 120 x 30 x 8 cm
Other sizes available for +20 pcs

Edging

20 cm straight edge for Silestone®
12 mm straight edge for Dekton®
Skirt: 125 mm / 160 mm

Benchtop

Length from 59 to 320* cm
Width from 40 to 60 cm

* Jumbo slab only for Silestone®. For the maximum length, continuity of veins in the side skirts is not possible.

Available colours

Available in all Silestone® 20 mm colours, polished or suede and Dekton® 12 mm colours. Please scan the below QR code to check the latest portfolio of Silestone® and Dekton® colours



Silence



Wash basin with a design that provides both the warmth and tranquillity that the most relaxing bathroom seeks. A silent waterfall for ultimate well-being.

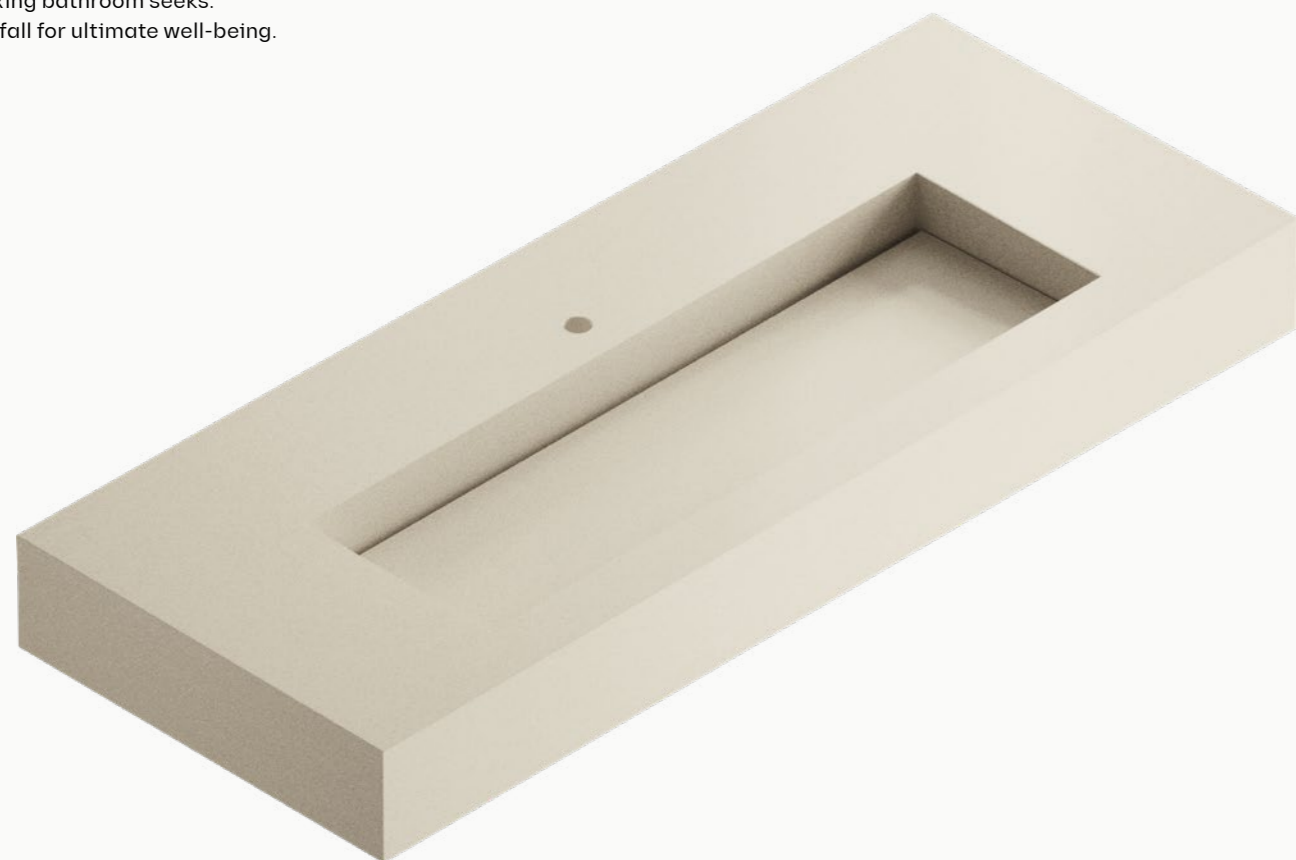

Characteristics

1. Linear drainage (not accessible for cleaning)
2. Almost imperceptible drainage slope.
3. Additional basins can be supplied and fitted.
4. Custom options for benchtop as: towel rails, cut outs, side legs (non structural), skirt heights, etc.
5. Grid sink plug valve included (cannot be closed).
6. Support bars included (for benchtops with skirt).
7. Possibility of bespoke basin solutions for +20 pcs.

Tap

With or without drill holes for taps

Integrated basin

Standard S: 49 x 30 x 8 cm
Standard M: 90 x 30 x 8 cm
Standard L: 120 x 30 x 8 cm
Other sizes available for +20 pcs

Edging

20 mm straight edge for Silestone®
12 mm straight edge for Dekton®
Skirt: 125 mm / 160 mm

Benchtop

Length from 59 to 320* cm
Width from 40 to 60 cm

* Jumbo slab only for Silestone®. For the maximum length, continuity of veins in the side skirts is not possible.

Available colours

Available in all Silestone® 20 mm colours, polished or suede and Dekton® 12 mm colours. Please scan the below QR code to check the latest portfolio of Silestone® and Dekton® colours



HLine Flex

DEKTON® silestone®

The perfect combination between a Silestone® or Dekton® benchtop and an under counter ceramic wash basin, providing full functionality and ease of cleaning for your project.



Characteristics

1. Sanitary porcelain basin.
2. Concealed overflow.
3. Additional basins can be supplied and fitted.
4. Custom options for benchtop as: towel rails, cut outs, side legs (non structural), skirt heights, etc.
5. Click-clack valve included.
6. Support bars included (for benchtops with skirt).

Tap

With or without drill holes for taps

Overflow

With overflow

Under benchtop ceramic basin

Standard: 49 x 30 x 10 cm

Edging

12 mm straight edge
Silestone® / Dekton®
Skirt: 210 mm

Benchtop

Length from 60 to 320* cm
Width from 46 to 60 cm

* Jumbo slab only for Silestone®. For the maximum length, continuity of veins in the side skirts is not possible.

Available colours

Available in all Silestone® 12 mm colours, polished or suede and Dekton® 12 mm colours. Please scan the below QR code to check the latest portfolio of Silestone® and Dekton® colours



HLine Urban

DEKTON® silestone®

A combination of Silestone® or Dekton® benchtop and ceramic benchtop wash basin, featuring a modern design and suitable for all needs.



Characteristics

1. Basin made of porcelain.
2. Modern rounded design.
3. Without overflow and tap ledge.
4. Possibility of adding more basins and decide the positioning
5. Custom options for benchtop as: towel rails, cut outs, side legs (non structural), skirt heights, etc.
6. Click clack valve included
7. Includes supports bars for benchtops with skirts

Tap

With or without drill holes for taps

Cubeta cerámica top

Standard: Ø45 x 14 mm

Edging

12 mm straight edge
for Silestone® and Dekton®
Skirt: 100 mm

Benchtop

Length from 45 to 320* cm
Width from 45 to 60 cm

* Jumbo slab only for Silestone®. For the maximum length, continuity of veins in the side skirts is not possible.

Available colours

Available in all Silestone® 12 mm colours, polished or suede and Dekton® 12 mm colours. Please scan the below QR code to check the latest portfolio of Silestone® and Dekton® colours



HLine Bath Top

DEKTON® silestone®

A new concept designed for shelves or benchtops in the bathroom. A solution that will add a sophisticated touch to this special space of your home.



Characteristics

1. Fully customisable: tap or drain drill holes for benchtop wash basins, rough or polished cut-outs for recessed or under counter wash basins, etc.
2. Suitable for use with basins made of any material.
3. Elements can be placed individually.
4. Custom options for benchtop as: towel rails, cut outs, side legs (non structural), skirt heights, etc.
5. Support bars included (for benchtops with skirt).

Drill holes

With or without drill holes

Edging

12 mm straight edge for Silestone® and Dekton®
Skirt: 60 / 100 / 210 mm

Benchtop

Length from 60 to 320* cm
Width from 30 to 60 cm

* Jumbo slab only for Silestone®. For the maximum length, continuity of veins in the side skirts is not possible.

Available colours

Available in all Silestone® 12 mm colours, polished or suede and Dekton® 12 mm colours. Please scan the below QR code to check the latest portfolio of Silestone® and Dekton® colours



Shower trays

Designs that perfectly fit the space.

Manufactured in non-slip finishes such as Dekton® Grip, Grip+ and sandblasted Silestone®, our portfolio of shower trays achieves visual consistency throughout the space by integrating all the different features. A single surface for all applications, resulting in an atmosphere of great aesthetic harmony, balance and spaciousness.



5
YEAR
COSENTINO
WARRANTY

Shower trays

Full product range

Five models of customisable shower trays in a wide range of colours and finishes, which adapt to any space and technical requirement, no matter how complicated it may seem.



Exelis
Silestone®

P. 226



Kador Suite
Silestone®

P. 228



Rainfloor
Dekton®

P. 222

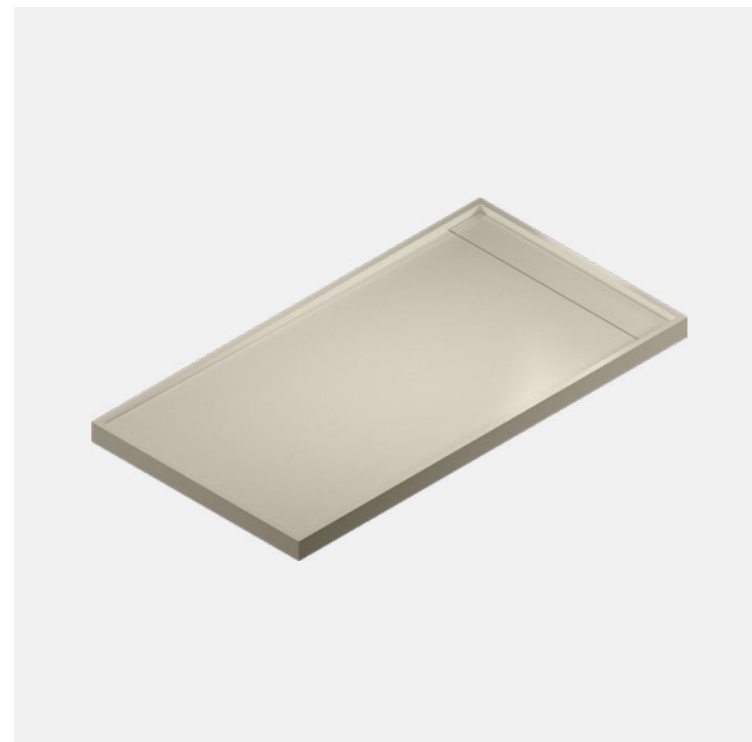

Katräl
Dekton®

P. 224



Wakka
Silestone®

P. 230



Wakka Brim
Silestone®

P. 232

Rainfloor

≡ DEKTON®

Solution according to the different design trends in the shower area. Combine Dekton® with any evacuation system available on the market: grilles in steel, ABS or covered with Dekton® itself. An elegant and quality product to give a touch of distinction to the bathroom.

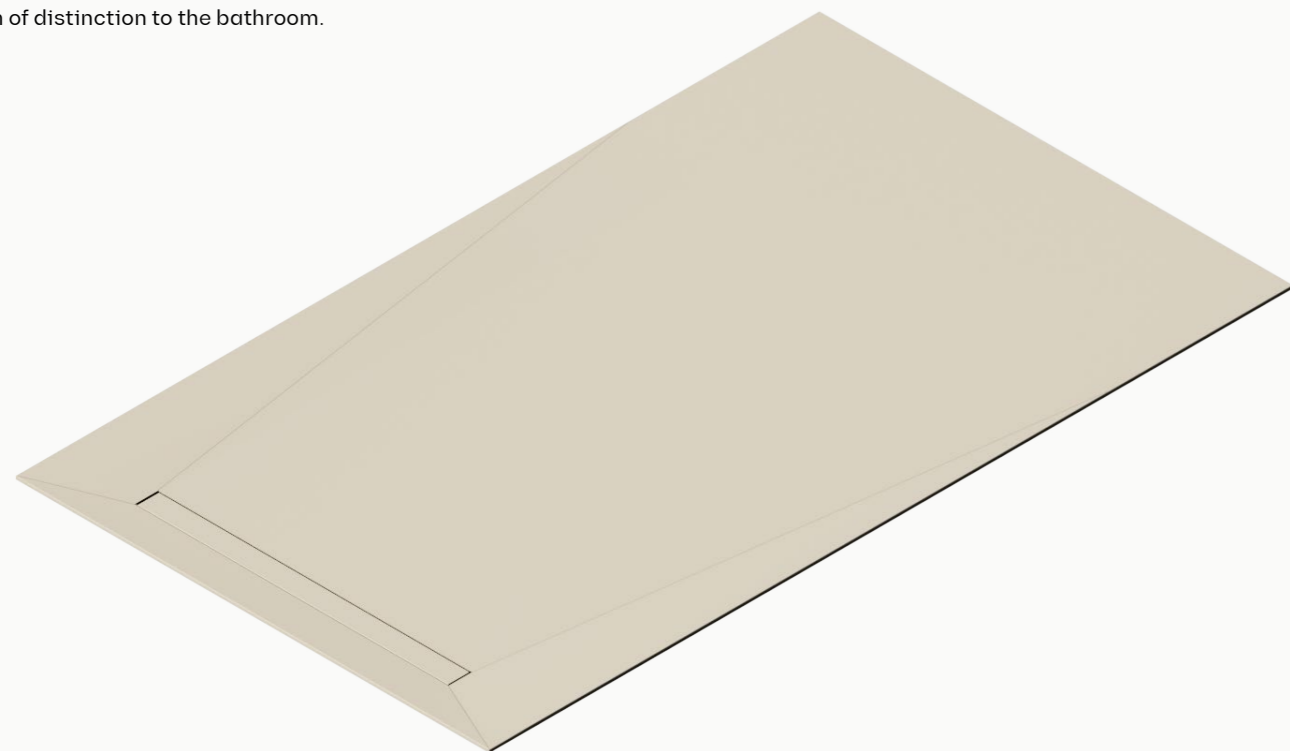

Characteristics

1. Premium bespoke integrated shower flooring.
2. Versatile solution integrated with the rest of the finishes.
3. Flush fitted shower flooring.
4. With the best textured finishes Dekton® Grip/Grip+.
5. Suitable for a wide variety of drainage systems.
6. 5 year warranty for antislip finishes.
7. Easy on-site installation.
8. Possibility to send the pieces already cut or to cut them on site.

Dimensions

Standard cladding format
Length from 71 to 159 cm
Width from 71 to 142 cm

Made to measure

Recommended thickness

8 mm

Surface

Dekton® Grip anti-slip finish (Class B, DIN 51097) and Grip + (Class C, DIN 51097).

Available colours

Available in all Dekton® 8 and 12 mm colours. Please scan the below QR code to check the latest portfolio of Dekton® Grip/Grip+ colours



Katräl

DEKTON®

The new framed shower tray in Dekton®, with a versatile and smart design, where the drain is covered in the same material to aim the perfect visual continuity in your bathroom space.

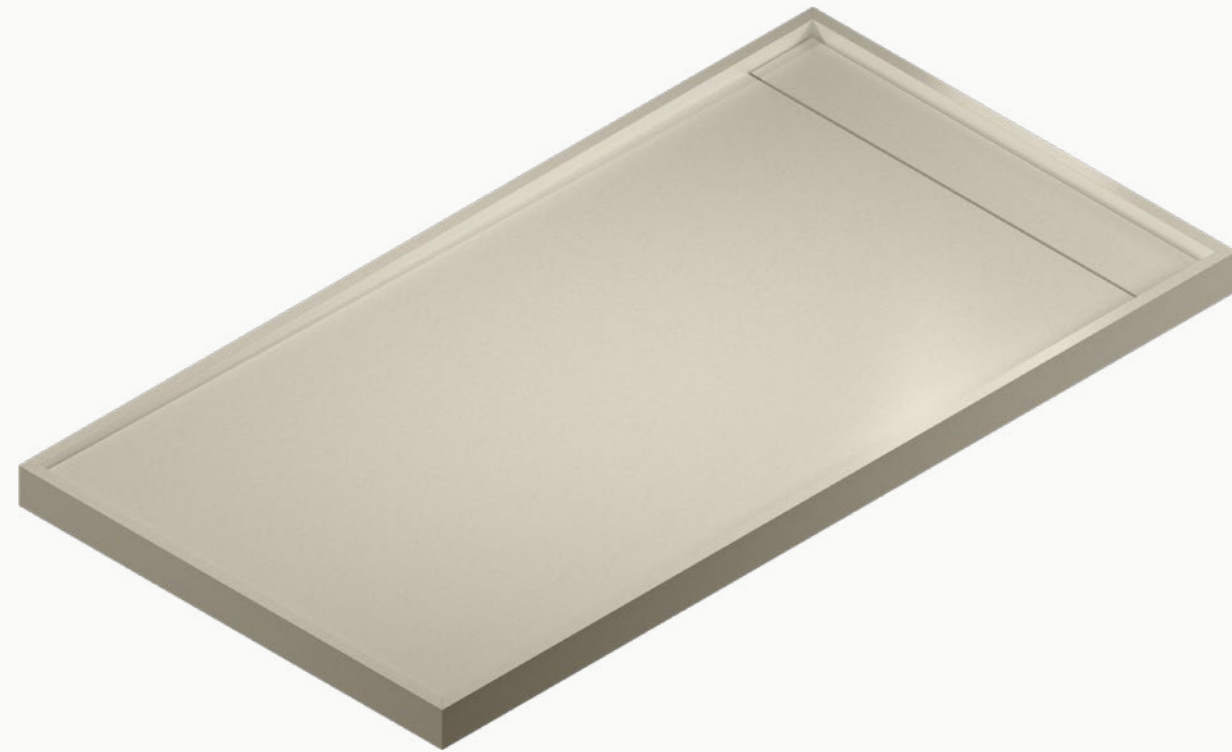

Características

1. Standard perimeter frame height 6.5 cm and width 2 cm, polished on the inside.
2. Hidden drainage area for perfect integration with the rest of the elements.
3. Versatile solution available in a wide range of measurements.
4. With the best textured finishes Dekton® Grip/Grip+.
5. 5 year warranty for antislip finishes.
6. Optional cut-outs to suit space available on request.
7. Installation flush with the floor or on top.
8. Valve with siphon and stainless steel shower drain included.

Valve

Centered in one of the short side of the piece

Perimeter frame

2 cm flat surface for optimum positioning of the shower screen

Dimensions

Length from 70 to 200 cm
Width from 70 to 120 cm

Edging

65 mm straight, polished on the inside

Surface

Dekton® Grip anti-slip finish (Class B, DIN 51097) and Grip + (Class C, DIN 51097).

Available colours

Available in all Dekton® 12 mm colours. Please scan the below QR code to check the latest portfolio of Dekton® Grip/Grip+ colours



Shower trays



Exelis



A simple but robust design, with a fourway drainage system suitable for any need. Its textured finish gives the shower tray the highest anti-slip properties.



Characteristics

1. Flat perimeter with elegant round corners.
2. Four-way drainage system suitable for any need.
3. Possibility to change the position of the valve where needed (depending on the dimension of the tray).
4. Optional cut outs to suit space available on request.
5. Optional side slot for shower screen installation.
6. Installation flush level with the floor or on top.
7. Valve with siphon and stainless steel shower drain included.

Valve

Custom position of the valve.

Perimeter area

4 cm flat surface for optimum positioning of the shower screen

Dimensions*

Length from 70 to 320* cm
Width from 70 to 150* cm

*Jumbo slab only. N-Boost treatment is not applied to sandblasted areas.

Edging

30 mm straight polished

Surface

Sandblasted anti-slip finish all over (Class B, DIN 51097)

Available colours

Available in all Silestone® 30 mm colours, polished. Please scan the below QR code to check the latest portfolio of Silestone® colours



Kador Suite



Its perimeter frame design, fully formed, ensures perfect leak tightness during showering. drainage slope to a full width linear water collection area.



Characteristics

1. Standard perimeter frame 5 cm high and 2 cm wide, which can be extended to 3, 4 or 5 cm wide.
2. Extra cover for the drainage area available.
3. Soft sandblasted strips for easy cleaning.
4. Optional cut-outs to suit space available on request.
5. Optional side slot for shower screen installation.
6. Installation flush with the floor or on top.
7. Valve with siphon and stainless steel shower drain included.

Valve

Custom positioning

Perimeter frame

2 cm flat surface for optimum positioning of the shower screen

Dimensions

Length from 70 to 200* cm
Width from 70 to 150* cm

*Jumbo slab only. N-Boost treatment is not applied to sandblasted areas.

Edging

50 mm straight polished

Surface

Sandblasted strips (Class B DIN 51097)

Available colours

Available in all Silestone® 20 mm colours, polished or suede. Please scan the below QR code to check the latest portfolio of Silestone® colours



Wakka



Made in one piece, without vertical joints. Its single slope makes it functional and easy to fit into the bathroom floor, providing a simple, practical and elegant design.



Characteristics

1. Made in one piece, with no additional material that would require vertical joints.
2. Designed for integration and continuity with the surrounding elements.
3. Soft sandblasted strips for easy cleaning.
4. Optional cut-outs to suit space available on request.
5. Installation flush with the floor (recessed).
6. Valve with siphon and stainless steel grid included.

Valve

Centered in one of the short side of the piece

Side frames

1.5 cm flat surface for optimum positioning of the shower screen

Dimensions

Length from 70 to 250* cm
Width from 70 to 150* cm

*Jumbo slab only. N-Boost treatment is not applied to sandblasted areas.

Edging

Decreasing edge from 30 to 5 mm

Surface

Sandblasted strips (Class B DIN 51097)

Available colours

Available in all Silestone® 30 mm colours, polished or suede. Please scan the below QR code to check the latest portfolio of Silestone® colours



Wakka Brim



An eye-catching tray, with a sophisticated and technological look suitable for all uses. Choose a Wakka tray with two additional side frames, without vertical joints.



Characteristics

1. Tray with two side frames, with a subtle chamfer towards the interior to facilitate water collection.
2. Disruptive and innovative design compared to traditional shower trays.
3. Extra cover for the drainage area available.
4. Soft sandblasted strips for easy cleaning.
5. Optional cut-outs to suit space available on request.
6. Installation flush with the floor or on top.
7. Valve with siphon and stainless steel shower drain included.

Valve

Centered in one of the short side of the piece

Side frames

2.5 cm flat surface for optimum positioning of the shower screen

Dimensions

Length from 70 to 250* cm
Width from 70 to 150* cm

*Jumbo slab only. N-Boost treatment is not applied to sandblasted areas.

Edging

30 mm straight polished

Surface

Sandblasted strips (Class B, DIN 51097)

Available colours

Available in all Silestone® 30 mm colours, polished or suede. Please scan the below QR code to check the latest portfolio of Silestone® colours



Custom design operations

Wash basins and benchtops

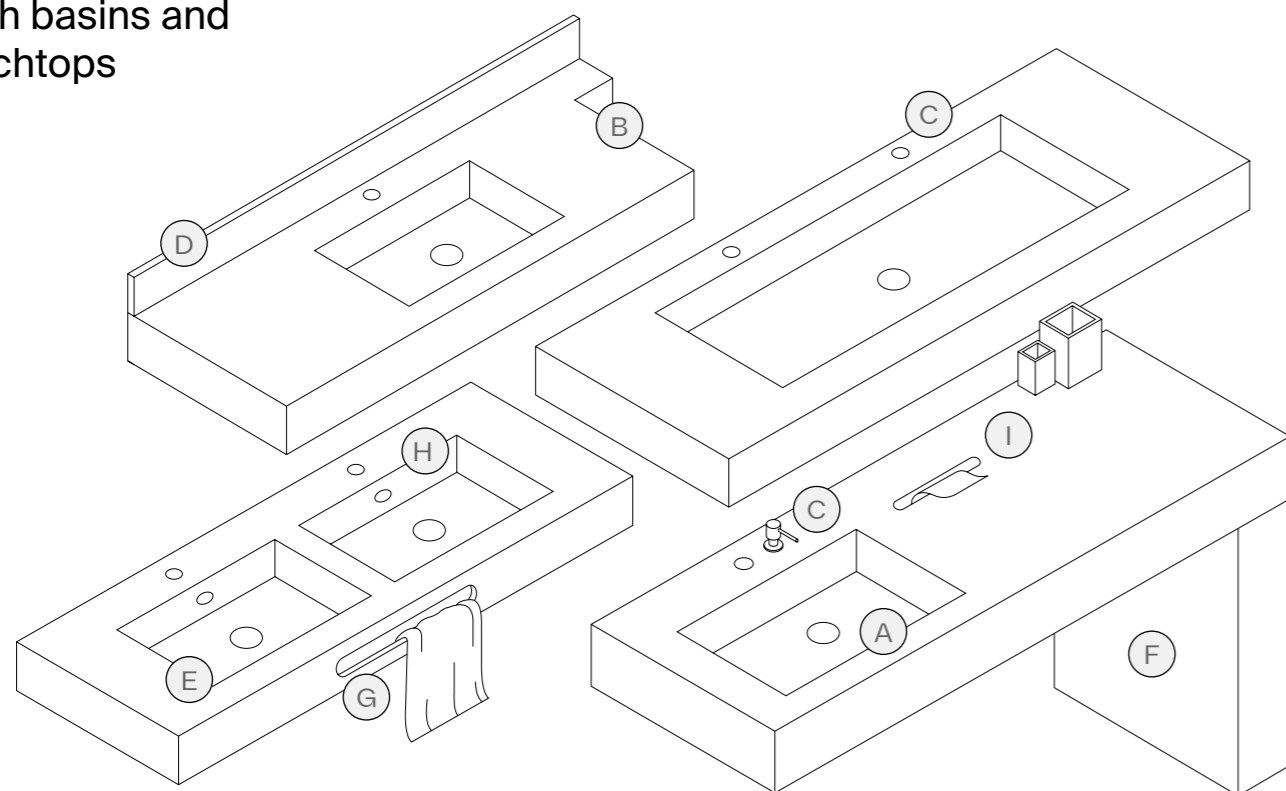

- A. Change in basin position.
- B. Mortises in the benchtop to fit the space.
- C. Additional drill hole for tap/soap dispenser (1 pc. per extra basin is included).
- D. Custom-made trim.
- E. Additional basin.
- F. Extra leg with butt or mitre joint (maximum size 90 x 60 cm. Width according to standard wash basin skirt).
- G. Towel rail (distance between wash basin and edge must be ≥ 9 cm).
Small: 40 x 5 cm
Medium: 60 x 5 cm
Large: 80 x 5 cm
- H. Overflow (depending on model).
- I. Cut out for tissue box (15 x 3 cm).

Customised operations

Polished cut out (for under vanity top up to 60 x 40 cm)

Rough cut-out (up to $\varnothing 8$ cm, for vanity top drain)

Extra cover

Simplicity and Reflection.



Wash basin installation guide

Access the guide by scanning the QR code.



Shower trays

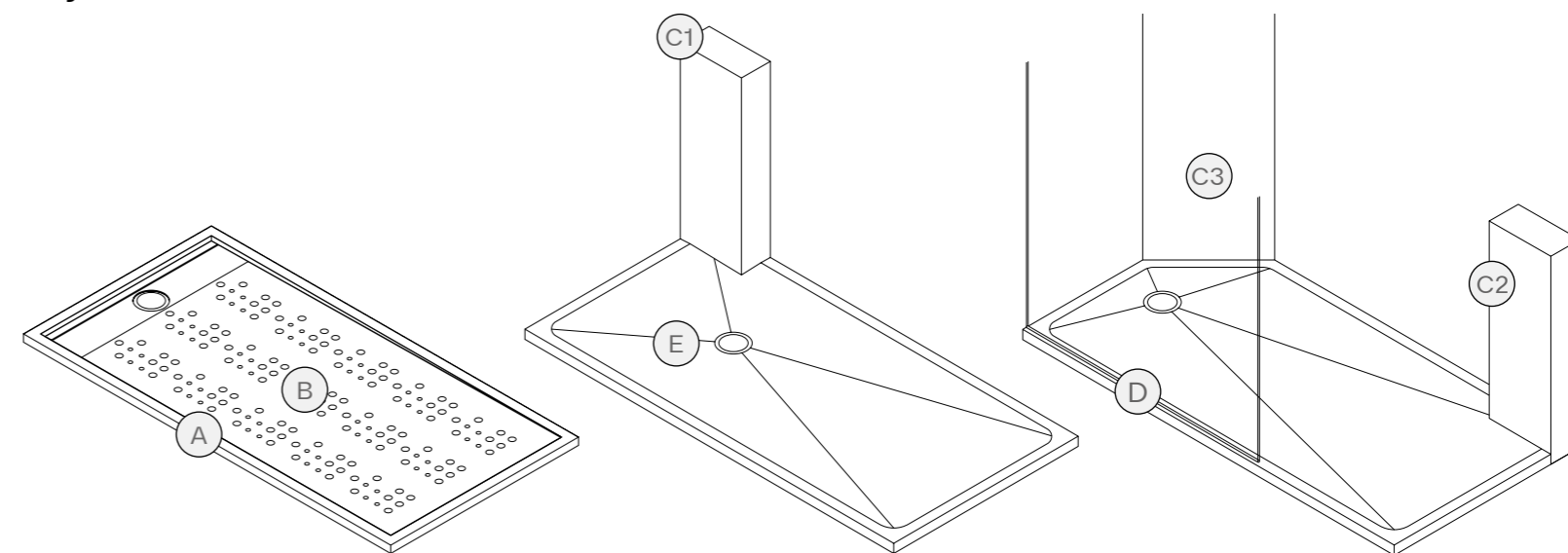

A. **Kador Suite:** Perimeter frame (3, 4 or 5 cm) for shower screen fitting.

B. **Kador Suite:** customisable sandblasting, subject to slip analysis.

C1. **Exelis:** Straight cut in the shower tray valve area to suit the space.

C2. All: Straight cut in the rear area of the shower tray to suit the space.

C3. All: Diagonal cut in the shower tray to suit the space.

D. **Kador Suite and Exelis:** Side cut-out for shower screen installation.

E. **Exelis:** Change of valve position (subject to certain limits).

Extra cover

Kador Suite and Wakka Brim.



Shower tray installation guide

Access the guide by scanning the QR code.



Accessories



Accessories for wash basins



Round click-clack basin waste ⁽¹⁾

Wash basins

Evita, Marie, Elegance, Symmetry, HLine Flex and HLine Urban

Technical information

Outlet connection: Ø32 mm (1 1/4")

Water flow: Qmax. 43 l/m

Code: 307383



Colour adapter for wash basin valve

Wash basins

Evita, Marie, Elegance, Symmetry, HLine Flex and HLine Urban

Technical information

Outside diameter: 62 mm

Inner diameter: 30 mm

Overflow: compatible

Code: 347138 (Matt Black), 347153 (Brushed Gold) and 347154 (Brushed Nickel)



Flat waste strainer ⁽¹⁾

Wash basins

Armony, Simplicity, Reflection and Silence

Technical information

Outlet connection: Ø32 mm (1 1/4")

Water flow: Qmax. 56 l/m

Code: 341538

Accessories for shower



Shower tray valve with removable grate and siphon ⁽⁴⁾

Shower trays

Exelis, Kador Suite, Wakka and Wakka Brim

Technical information

Outlet connection: Ø4 cm (1 1/2") x 11.5 cm

Water flow: Qmax. 43 l/m

Siphon: 30 mm

Code: 339708

1. Chrome valve supplied with the basin.
2. Adapter supplied when ordering an overflow as an extra. To be specified at the point of order when required.
3. Two supports supplied when ordering a wash basin with skirt. An extra support will be included for each additional basin ordered, at no extra cost. If more supports are required, please include them manually in the order.
4. Valve supplied with each shower tray.



Overflow adapter ⁽²⁾

Wash basins

Elegance and Evita

Technical information

Max. length: 300 mm (11 4/5")

Water flow: Qmax. 15 l/m

Code: 324644



Colour adapter for overflow

Wash basins

Elegance and Evita

Technical information

Max. length: 320 mm (12 3/5")

Water flow: Qmax. 15 l/m

Code: 347147 (Matt Black), 347139 (Brushed Gold) and 347129 (Brushed Nickel)



Telescopic support ⁽³⁾

Wash basins

Elegance, Armony, Symmetry, Simplicity, Reflection, Silence, Evita, Marie, HLine Flex/Urban and Bath Top.

Technical information

Length without extension: 355 mm (14")

Length with extension: 610 mm (24")

Height: 60 mm (2 1/2") / Width: 40 mm (1 3/5")

Anchor plate: 90 x 110 x 5 mm

(3 1/2 x 4 1/3 x 1/5")

Code: 347265



Certifications

At Cosentino® we have a strong commitment to meeting the needs of our customers and suppliers and to the environment through the responsible management of our resources. To this end, we are committed to innovation and continuous improvement of our processes, products and services at a global level.

Cosentino®

ISO 9001
ISO 14001
ISO 20400
ISO 50001
UNE 15896
Leed and Breeam credits for Silestone®, Dekton® and Sensa by Cosentino®
CSR (verified by KPMG) based on GRI (Global Reporting Initiative)

Silestone®

Declare Label
EPD (Environdec)
VOC (UL) Greenguard and Gold
VOC (Eurofins) A+

Dekton®

Declare Label
DGNB Label
EPD (Environdec)
VOC (UL) Greenguard and Gold
VOC (Eurofins) A+
Chemical Spot Test (SEFA)
Fire Safety Certification APF-1525 (Applus), in accordance with EN 13501-1
Combustibility Test (CSIRO), in accordance with AS 1530.1
Fire Euroclass A1 (Tecnalia), in accordance with 13501-1
Burning Characteristics (QAI), in accordance with ASTM E84-15b
IMO Module B 50171/A2 MED, in accordance with the Marine Equipment Directive 2014/90/EU - Ships.
IMO Module D SMS.MED2.D/109819/A.0, in accordance with the Marine Equipment Directive 2014/90/EU - Ships.
USCG Module B 164.117 / EC2690 - Boats. Fire Test NFPA 285 (Tecnalia)

Bathroom

Wash basins

DoC (Declaration of Conformity), in accordance with EN 14688
CSA 800580/IAPMO
TJ5065 (QAI), in accordance with CSA B45.5-17 / IAPMO Z124

Shower trays

DoC (Declaration of Performance), in accordance with EN 14527
Slip-Resistant DIN 51097
CSA 800580/IAPMO TJ5065 (QAI), in accordance with CSA B45.5-17 / IAPMO Z124

Cosentino® Warranty

Wash basins
Shower trays
Bathroom benchtops

Cosentino® standard warranty letter

This Letter of Warranty (hereinafter, the 'Warranty') shall only be fully valid when the consumer has registered the project within 6 months of the purchase of the product, as indicated in the relevant section, and when the consumer submits the original invoice or purchase receipt (indicating the date of purchase and the name of the dealer of the product). The consumer shall send the defective product to COSENTINO GLOBAL S.L.U. (hereinafter, **COSENTINO**). In order to be effective, this Warranty must be registered online on the website www.cosentino.com. This Warranty is transferable.

COSENTINO® reserves the right not to offer the warranty service free of charge if the requirements set out in the previous paragraph are not met, or if the information provided by the consumer is false, incomplete or illegible. This Warranty is intended for non-professional end users and shall be considered applicable for residential use, such as any building or facility for private accommodation, whether it is a single family or multi family dwelling.

End Products Manufactured by Cosentino®

This section of the Warranty is limited to end products manufactured under any of the COSENTINO® brands in the form of three-dimensional products, such as kitchen sinks, wash basins, bathroom benchtops and shower trays (hereinafter, the 'End Products'), and covers any manufacturing defects in such products for a period of **FIVE (5) YEARS** from the date of purchase. All this under the terms, conditions and limitations described for the rest of SILESTONE® or DEKTON® by Cosentino® products in this document and also available on the website.

This Warranty is only valid when the end products have been correctly installed (in accordance with the applicable regulations and the specific assembly instructions), and have been used correctly according to their intended application (Use, Care and Maintenance Guide). Consumable items (rubber elements, seals, valves, etc.) are not covered under this Warranty.

Warranty Registration

To register as a holder of this Warranty, it must be activated via www.cosentino.com. This website requires certain information for registration, including information relating to the point of sale and/or the marble supplier, as well as the customer. Therefore, we recommend that customers register directly with the point of sale or marble supplier. At the end of the registration, the customer may print this Warranty for their use. In order to benefit from the Warranty, it must be registered within six (6) months of purchase.



⁽¹⁾ Check each approved model.

**COSENTINO CITY CENTRE
AUSTRALIA**

130 Elizabeth Street,
Sydney, NSW, 2000
Tel: 02 8311 1518 / 02 8311 1519
infoaustralia@cosentino.com

COSENTINO SYDNEY HUB

270 Beech Rd, Casula, NSW, 2170
Tel: 02 8311 1516 Accounts: 8311 1517
infoaustralia@cosentino.com

COSENTINO CENTRE BRISBANE

Yatala QLD 4207, 8 Gassman Drive,
Tel: 07 3451 0600
infobrisbane@cosentino.com

**COSENTINO CENTRE
VICTORIA NORTH**

27 Transport Drive,
Somerton VIC 3062
T: 03 9308 5255
infomelbourne@cosentino.com

**COSENTINO CENTRE
MELBOURNE SOUTH**

44 Corporate drive,
Heatherton, VIC 3202
03 9552 0400 / 03 9551 0896
infomelbourne@cosentino.com

**COSENTINO CENTRE
SOUTH AUSTRALIA**

6 Capelli Road, Wingfield SA 5013
Tel: 08 7123 3871
infoadelaide@cosentino.com

**COSENTINO CENTRE
WESTERN AUSTRALIA**

12 Callaway Street,
Wangara, WA, 6065
Tel: 08 6365 4231
infoperth@cosentino.com

**COSENTINO NEW ZEALAND
(VAT 120-068-895)**

23 Allens Rd
East Tamaki, Auckland 2013
po Box 230221 Botany 2163
Tel: 092749406
infonewzealand@cosentino.com

REV. 02 - 06/2023